

SECRETARY

The Bell System Technical Journal

*Devoted to the Scientific and Engineering Aspects
of Electrical Communication*

EDITORIAL BOARD

J. J. Carty Bancroft Gherardi F. B. Jewett
E. B. Craft L. F. Morehouse O. B. Blackwell
H. P. Charlesworth E. H. Colpitts
R. W. King—*Editor*

Published quarterly by the American Telephone and Telegraph Company,
through its Information Department, in behalf of the Western Electric
Company and the Associated Companies of the Bell System

Address all correspondence to the Editor
Information Department

AMERICAN TELEPHONE AND TELEGRAPH COMPANY
195 BROADWAY, NEW YORK, N. Y.

50c. Per Copy

Copyright, 1923.

\$1.50 Per Year

Vol. II

JANUARY, 1923

No. 1

Theory and Design of Uniform and Composite Electric Wave-filters

By OTTO J. ZOBEL

THE electric wave-filter, as regards its general transmission characteristics and its extremely important rôle in communication systems, is well known. Its physical theory was discussed in detail in the preceding number of this Journal by its inventor, G. A. Campbell. In the present paper it is proposed to present systematic general methods of wave-filter design, together with representative designs, which have been developed in connection with the practical utilization of this device in the plant of the Bell System.

First is considered a general theory of design combining physical and analytical considerations which gives explicitly the structure of a uniform type of wave-filter having any preassigned transmitting and attenuating bands as well as desirable impedance and quite arbitrary attenuation characteristics. Next, this theory is applied to the design of a low-and-band pass wave-filter from which are derived design formulæ for all the practical uniform wave-filter structures in present use, belonging to the classes low pass, high pass, low-and-high pass, and band pass. Then the subject of composite wave-filters is taken up, these being non-uniform wave-filter networks

obtained by combining sections of wave-filters having equivalent characteristic impedances but different propagation constants. Among others, a superior advantage of composite over uniform wave-filters is shown to be their greater flexibility of design, as a result of which composite wave-filters are often the only means of meeting severe design requirements. Many of the methods here used are found to have further application in general recurrent network design.

The ideal toward which wave-filter design is usually directed is a finite network having any preassigned transmitting and attenuating bands, zero attenuation and a terminal characteristic impedance equal to any one preassigned constant resistance in all transmitting bands, and infinite attenuation throughout all attenuating bands. Due to such an

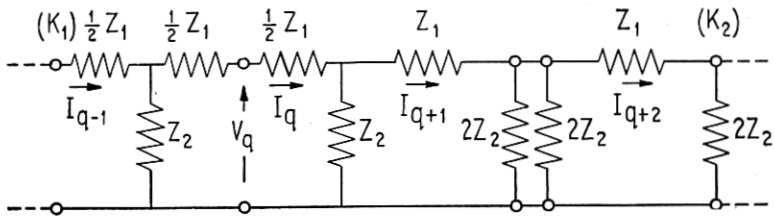

Fig. 1—Ladder Type Recurrent Network

impedance characteristic, at frequencies in the transmitting bands there would be no loss of transmitted energy if the network were inserted between two resistances, a generator and a receiver, each having a constant resistance of this same magnitude, approximately the case of two transmission lines. The infinite attenuation of the network to currents of all other frequencies would effectively prevent energy transmission through it.

Practically, such an ideal has not been attained but the methods developed here lead to designs which can approximate it rather closely. No attempt will be made to give the construction of wave-filter elements minimizing energy dissipation, as we shall be concerned mainly with a determination of the magnitude and locations of the elements in the network. It may be stated, however, that the less dissipative the elements the more nearly will the ideal of free transmitting bands be reached.

PART I. THEORY OF DESIGN

The uniform recurrent network specifically considered in this design method is the ladder type of Fig. 1 having identical series impedances

z_1 and identical shunt impedances z_2 , each of which has a physically realizable structure. For purposes of illustration, at the left end is shown a mid-series section whose two series impedances $\frac{1}{2}z_1$ are each half a full series impedance element. On the right is a mid-shunt section, its two shunt admittances $\frac{1}{2z_2}$ each being half that of a full shunt admittance; its shunt impedances are therefore, $2z_2$. Corresponding to these two mid-point terminations are the mid-series and mid-shunt characteristic impedances K_1 and K_2 , respectively.

When any ladder type design has been obtained its mid-series and mid-shunt sections, being respectively in the form of three star-connected (T) and three delta-connected (Π) impedances, may serve as the basis of transformations by ordinary means to determine the elements of other uniform types (such as the lattice type shown in Fig. 6) having equivalent properties. Generally such equivalent uniform types are not as economical as the ladder type either due to difficulties of construction or a larger number of elements per section. The theory of composite wave-filters is included in that of uniform types as here presented and so does not require a separate treatment.

Fundamental Formulae

The mathematical formulae upon which the design rests follows, their derivation being given in Appendix I.

$$\left. \begin{aligned} \cosh \Gamma &= 1 + \frac{1}{2} \frac{z_1}{z_2} = 1 + \frac{1}{2} \gamma^2, \\ K_1 &= \sqrt{z_1 z_2 + \frac{1}{4} z_1^2} = \sqrt{1 + \frac{1}{4} \gamma^2} k, \\ K_2 &= \frac{z_1 z_2}{\sqrt{z_1 z_2 + \frac{1}{4} z_1^2}} = \frac{k}{\sqrt{1 + \frac{1}{4} \gamma^2}} = \frac{k^2}{K_1}, \\ e^{-\Gamma} &= \frac{2K_1 - z_1}{2K_1 + z_1} = \frac{2z_2 - K_2}{2z_2 + K_2}, \end{aligned} \right\} \quad (1)$$

in which

z_1, z_2 = series and shunt impedances per section,
 $\Gamma = A + iB$ = propagation constant per section,
 K_1, K_2 = mid-series and mid-shunt characteristic impedances.

$$\gamma = \alpha + i\beta = \sqrt{\frac{z_1}{z_2}},$$

and $k = \sqrt{z_1 z_2},$

wherein γ and k have the significance of being the propagation constant and characteristic impedance of the corresponding smooth line, *i.e.*, a line having series and shunt impedances z_1 and z_2 , respectively, per unit length uniformly distributed along the line.

When z_1 and z_2 are dissimilar reactances, as in a non-dissipative wave-filter, *currents of frequencies within continuous frequency bands can be transmitted without attenuation* and the location of these bands on the frequency scale may be found from the conditions which must there be satisfied. As derived from the first equation of (1) the latter are

$$A = 0,$$

and

$$\cos B = 1 + \frac{1}{2} \frac{z_1}{z_2}. \quad (2)$$

Since the cosine limits are ± 1 this shows that free transmission may occur at all frequencies corresponding to impedance ratio values satisfying the relation

$$-1 \leq \frac{z_1}{4z_2} \leq 0, \quad (3)$$

a result which may be stated as follows:

The transmitting bands in a ladder type wave-filter having series and shunt impedances z_1 and z_2 , respectively, include all frequencies at which these impedances are of opposite signs and the absolute value of z_1 is not greater than that of $4z_2$. This statement is useful in roughly determining the relative positions of such bands on an impedance diagram where z_1 and $4z_2$ have been plotted as functions of frequency.

In the attenuating bands corresponding to the remainder of the frequency range we have for the non-dissipative case

$$\begin{aligned} \text{and} \quad \cosh A &= \pm \left(1 + \frac{1}{2} \frac{z_1}{z_2} \right), \\ \sin B &= 0, \end{aligned} \quad (4)$$

the sign above being taken such as to make the right member positive.

While the above formulae contain the necessary relations for wave-filter action they do not specify the physical structure of the reactance network. Hence we need to combine with them certain properties of physical reactances to arrive at a structure having desired characteristics. In wave-filter design all resistances in the physical reactance elements, although being unavoidable in construction, are

neglected as they produce but secondary effects. When allowed for later their most pronounced effect is the introduction of small attenuation in the transmitting bands.

Reactance Theorems

The properties of physical reactances which are to be utilized may be stated in the following theorems:

1. *The reactance of any non-dissipative reactance network always has a positive slope with frequency, as well as abrupt changes from positive to negative infinity at anti-resonant frequencies, and may be represented identically (among others) either by a number of simple (series L and C) resonant components in parallel, or simple (parallel L and C) anti-resonant components in series.*

2. *To any non-dissipative reactance network there corresponds an inverse reactance network which is so related that the product of their impedances is a constant, independent of frequency.*

The proofs of these theorems are given in Appendix I, where with reactances which are known to be any series and parallel combinations of inductances and capacities the method of induction is readily applied. In the first theorem the simple component resonant at zero frequency is a single inductance and the one at infinite frequency a single capacity. Similarly the simple anti-resonant components corresponding to these limiting frequencies are single capacity and single inductance, respectively. In the second theorem, if we have given one reactance consisting of a number of simple anti-resonant components, all in series, the inverse network may be made up of the same number of simple resonant components all in parallel, each one of the latter corresponding to a particular one of the former. Moreover, any pair of these corresponding components are resonant and anti-resonant, respectively, at the same frequency and the ratio of inductance in one to capacity in the other is equal to the constant product of the two total impedances.

Phase Constant Theorem

The phase constant will not play any part in the present theory of design but it has this property: *The phase constant in a wave-filter always increases with frequency thruout each transmitting band.* As shown in Appendix I, this follows as a consequence of the positive slope of reactances. Consideration of this theorem will later be touched upon when discussing composite wave-filters.

1. "CONSTANT k " WAVE-FILTER HAVING ANY PREASSIGNED TRANSMITTING AND ATTENUATING BANDS

The "constant k " wave-filter belonging to any class¹ is defined as that ladder type wave-filter whose product of series and shunt impedances, and therefore characteristic impedance, k , of the corresponding smooth line, is constant independent of frequency.

The reasons for seeking the "constant k " wave-filter of any class are, briefly:

(1) Its physical structure is readily found which will give any preassigned transmitting and attenuating bands.

(2) Each of its two mid-point characteristic impedances passes thru the same values, different in the two cases, in all transmitting bands.

(3) Its design is preliminary to and furnishes a logical basis for the derivation of general wave-filters possessing desirable attenuation and impedance characteristics.

Letting the two impedances of the "constant k " wave-filter be denoted with extra suffixes as z_{1k} and z_{2k} , we have seen that if there is a relation between these impedances such that

$$z_{1k} z_{2k} = k^2 = \text{Constant}, \quad (5)$$

the series and shunt impedances of the "constant k " wave-filter must be inverse networks to each other. Only one of them, say z_{1k} , need then be

temporarily considered, the ratio $\frac{z_{1k}}{4z_{2k}}$, becoming $\left(\frac{z_{1k}}{2k}\right)^2$ which by (3)

shows that free transmission occurs wherever the series impedance passes with increasing frequency thru the values from $z_{1k} = -i2k$ to $z_{1k} = 0$, and $z_{1k} = 0$ to $z_{1k} = +i2k$. At each critical frequency separating a transmitting from an attenuating band z_{1k} has the value $z_{1k} = \pm i2k$. By (4) an attenuating band includes a frequency at which z_{1k} is anti-resonant. Hence, in a "constant k " wave-filter the transmitting and attenuating bands include the frequencies at which the series impedance is resonant and anti-resonant, respectively. The

¹ The class of a wave-filter, as defined in the present paper, is determined by the number of its transmitting bands and their general locations on the frequency scale; the type by its general structure. Thus, the low-band-and-high pass class transmits in a band including zero frequency, in one internal band, and in a band including infinite frequency. A class is complementary to another if its transmitting and attenuating bands correspond in order to the attenuating and transmitting bands, respectively, of the other. One class is higher, or lower, than another if it has in addition to those of the latter at least one more, or one less, transmitting or attenuating band.

critical frequencies separating these bands are the frequencies at which the series impedance equals $\pm i2k$.

With these known facts and the properties of reactance networks, the determination of the physical structure and design of any "constant k " wave-filter is a relatively simple matter. At the series-resonant frequency of any transmitting band both characteristic impedances K_{1k} and K_{2k} , using the same notation as above, have by (1) the value k . This indicates that if k has been chosen equal to the impedance of the line (assumed as a constant resistance) with which the wave-filter is to be associated there will be no impedance irregularity at the junction of the mid-terminated wave-filter and the line for any of these series-resonant frequencies. We shall put, therefore,

$$k = \sqrt{z_{1k}z_{2k}} = \text{Mean Line Resistance} = R, \quad (6)$$

which is assumed given, and R will have this meaning thruout the remainder of this paper. At the *critical frequencies* we then have to satisfy the conditions

$$z_{1k} = \pm i2R, \quad (7)$$

where also

$$K_{1k} = 0 \text{ and } K_{2k} = \infty.$$

If there are to be n transmitting bands z_{1k} may be designed out of n simple resonant components, *all in parallel*, wherein each component accounts for only one band. For example, with resonant components $z_{r1} \dots z_{rn}$, we have

$$z_{1k} = \frac{1}{\frac{1}{z_{r1}} + \dots + \frac{1}{z_{rj}} + \dots + \frac{1}{z_{rn}}}.$$

This is sufficient since, owing to the positive slope of reactance, there is bound to be but one anti-resonant frequency and attenuating band between every adjacent pair of resonant frequencies. It is obvious that the component corresponding to the zero frequency transmitting band is an inductance, l_{1k}^1 ; the component corresponding to any (j) internal transmitting band is an inductance, l_{ik} , and capacity, c_{1k}^j in series; and the component corresponding to the infinite frequency transmitting band is a capacity, c_{1k}^n .

The magnitudes of the inductances and capacities will be uniquely determined by satisfying the relations (7) at all the critical frequencies. For at the critical frequency of the zero frequency transmitting band $z_{1k} = +i2R$; at the lower critical frequency of any internal transmitting band $z_{1k} = -i2R$ and at the higher critical frequency $z_{1k} = +i2R$; at the critical frequency of the infinite frequency transmitting band $z_{1k} = -i2R$. Hence, no matter what "constant k "

wave-filter is considered, the number of restrictions imposed on z_{1k} at the critical frequencies will always equal the total number of inductances and capacities involved, whose magnitudes are therefore given by the solution of the simultaneous equations (7).

By the second reactance theorem a corresponding value of z_{2k} may be obtained by designing it out of n components, *all in series*, wherein each component is the inverse network of a component in the series impedance, the product of their impedances being equal to R^2 to satisfy (6). The component in z_{2k} corresponding to the zero frequency transmitting band is a capacity, c_{2k}^1 ; that to any (j) internal transmitting band is a simple anti-resonant component of inductance, L_{2k}^j , and capacity c_{2k}^j , in parallel; and that to the infinite frequency transmitting band is an inductance, l_{2k}^n . The relations between inductances and capacities of the corresponding components are given by

$$\frac{l_{1k}^1}{c_{2k}^1} = \dots = \frac{L_{1k}^j}{c_{2k}^j} = \frac{l_{2k}^j}{c_{1k}^j} = \dots = \frac{l_{2k}^n}{c_{1k}^n} = R^2, \quad (8)$$

which determine the elements of z_{2k} as soon as those of z_{1k} are found.

An alternative method is to focus our attention upon the attenuation requirements. To give n attenuating bands, z_{1k} may be designed out of n simple anti-resonant components, *all in series*, each component accounting for only one band. Representing these anti-resonant components by $z_{a1} \dots z_{an}$, the series impedance is

$$z_{1k} = z_{a1} + \dots + z_{aj} + \dots + z_{an}.$$

The component corresponding to the zero frequency attenuating band is a capacity, C_{1k}^1 ; that to any (j) internal attenuating band is a simple anti-resonant component of inductance, L_{1k}^j , and capacity C_{1k}^j , in parallel; and that to the infinite frequency attenuating band is an inductance, L_{1k}^n . As in the previous case z_{1k} must satisfy (7) at all the critical frequencies, which determines its elements. The corresponding shunt impedance, z_{2k} , may be designed out of n components, *all in parallel*, wherein each component is the inverse network of a component in the series impedance, their impedance product being R^2 . The components in z_{2k} for the three typical attenuating bands above considered in the discussion of z_{1k} are in the same order, an inductance, L_{2k}^1 , a simple resonant component of inductance, L_{2k}^j , in series with a capacity, C_{2k}^j , and a capacity, C_{2k}^n . We have here

$$\frac{L_{2k}^1}{C_{1k}^1} = \dots = \frac{L_{1k}^j}{C_{2k}^j} = \frac{L_{2k}^j}{C_{1k}^j} = \dots = \frac{L_{1k}^n}{C_{2k}^n} = R^2. \quad (9)$$

A general comparison of these two methods of designing a "constant k " wave-filter shows that the series impedances in the two cases have the same number of inductances and the same number of capacities. Since the total number of these elements is the same in both and the two impedances are made equal at a number of critical frequencies equal to this total number, these impedances are identical at all frequencies. Similarly for the shunt impedances; all of which agrees with the first reactance theorem and leads to the following conclusion.

As regards propagation constant and impedance characteristics, only one "constant k " wave-filter exists in each class, and the magnitudes of its series and shunt impedances, each of which contains elements equal in number to the critical frequencies, are uniquely determined by the preassigned critical frequencies and the magnitude of k . Its physical structure, however, is in general not unique.

The structure of these impedances may in all but the lowest classes be given a variety of different forms, the number of inductances remaining fixed as well as the number of capacities. In the low pass, high pass, low-and-high pass, and band pass classes, the above two modes of derivation give the same designs for their respective series and shunt impedances. In those of a higher class the designs so obtained are different and for more than three elements per impedance may be put in even other forms.

Taking the "constant k ", low-band-and-high pass wave-filter with critical frequencies f_0 , f_1 , f_2 , and f_3 , as an example, the first method gives the series impedance as an inductance in parallel with both a resonant component and a capacity, and the shunt impedance as a capacity in series with both an anti-resonant component and an inductance. The second method gives the structure shown in Fig. 2. Two other equivalent structures for the series impedance are possible; one is an inductance in parallel with the series combination of a capacity and an anti-resonant component, the other is a capacity in parallel with the series combination of an inductance and an anti-resonant component. Similarly the shunt impedance may have two other structures; one is a capacity in series with the parallel combination of an inductance and a resonant component, the other is an inductance in series with the parallel combination of a capacity and a resonant component. Relations between the element magnitudes are given in Appendix III, which contains general equivalent impedances. There being four equivalent structures for each of the series and shunt impedances this would mean a total of *sixteen possible structures* for this *one* "constant k " wave-filter. The impedance

and attenuation diagrams in Fig. 2 illustrate some of its properties. Especially is it to be noted that the infinite attenuations, occurring where the series impedance is anti-resonant, take place at frequencies f_{a1} and f_{a2} which are not arbitrary but depend entirely upon the critical frequencies f_0 , f_1 , f_2 and f_3 .

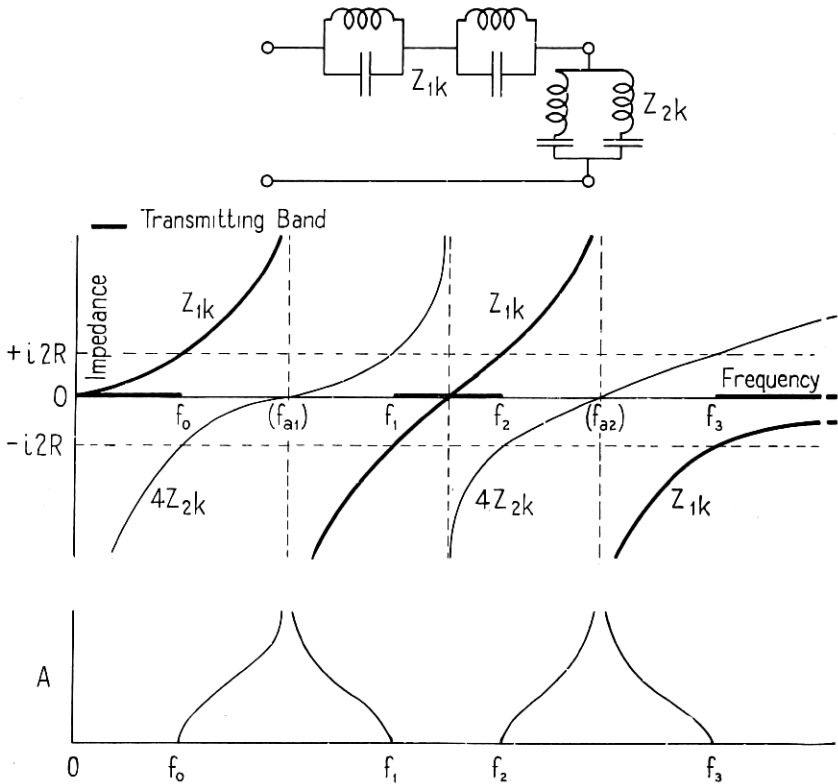

Fig. 2—"Constant k " Low-Band-and-High Pass Wave-Filter

It may be added that in "constant k " wave-filters every internal transmitting band is a confluent band formed by the junction of two bands occurring separately in a wave-filter of higher class but with the same configuration of elements.

Summarized, the above procedure for "constant k " wave-filter design is:

- (1) Obtain synthetically a structural form for the series impedance, z_{1k} , from either the transmission or attenuation requirements;

(2) Determine the magnitudes of all inductances and capacities in z_{1k} from the conditions, $z_{1k} = \pm i2R$ at all preassigned critical frequencies, where $R (=k)$ is the given mean line resistance;

(3) Derive a structure, in addition to the inductance and capacity magnitudes, of the shunt impedance, z_{2k} , considering the latter as an inverse network to z_{1k} , where $z_{1k}z_{2k} = R^2$.

2. GENERAL WAVE-FILTERS HAVING ANY PREASSIGNED TRANSMITTING AND ATTENUATING BANDS AND PROPAGATION CONSTANTS ADJUSTABLE WITHOUT CHANGING ONE MID-POINT CHARACTERISTIC IMPEDANCE.

It was shown above how a "constant k " wave-filter may always be designed so as to have any preassigned transmitting and attenuating bands. A method will now be given for deriving the two most general ladder types, each having one mid-point characteristic impedance equivalent at all frequencies to the corresponding mid-point characteristic impedance of the known "constant k " wave-filter; one of them has such equivalence at mid-series, and the other at mid-shunt. Because of this equivalence, these general wave-filters must necessarily have the same transmitting and attenuating bands as the "constant k " wave-filter which they include as a special case. Their propagation constants will be found to be adjustable over a wide range.

Mid-Series Equivalent Wave-Filter

Assume the known "constant k " wave-filter has n attenuating bands and that its series impedance derived by the second method has the form of n simple anti-resonant components in series, represented as

$$z_{1k} = z_{a1} + z_{a2} + \dots + z_{an}. \quad (10)$$

Its mid-series characteristic impedance is

$$K_{1k} = \sqrt{R^2 + \frac{1}{4}z_{1k}^2}. \quad (11)$$

Let the series and shunt impedances of the desired general wave-filter be z_{11} and z_{21} , respectively, where the second subscript 1 indicates that these impedances belong to the wave-filter which is to have mid-series equivalence with the "constant k " wave-filter. Then

$$K_{11} = \sqrt{z_{11}z_{21} + \frac{1}{4}z_{11}^2}, \quad (12)$$

and the *fundamental relation* is that

$$K_{11} = K_{1k}. \quad (13)$$

Certain inferences may be drawn as to the nature of the impedances z_{11} and z_{21} .

a. *The series impedance z_{11} is similar in form to the series impedance z_{1k} and is anti-resonant at the same frequencies as z_{1k} .* This follows directly from a comparison of formulae (11) and (12). For whenever z_{1k} is anti-resonant, corresponding to an attenuating band, K_{1k} is infinite, and to make K_{11} also infinite z_{11} must be anti-resonant irrespective of z_{21} in order to maintain an attenuating band at these frequencies.

b. *The shunt impedance z_{21} corresponding to the series impedance z_{11} and the given class of wave-filter may, in its most general form, be taken as a parallel combination of simple resonant components (series L and C) equal in number to the total number of inductances and capacities contained in z_{11} .* This is a consequence of a general conclusion based upon formulae (2) and (4) and the properties of reactances, namely that in an attenuating band corresponding to each branch of the series impedance frequency curve, where the absolute value of z_{11} passes once continuously thru all values from zero to infinity, the shunt impedance z_{21} can be resonant no more than once. Since, however, the number of branches in the z_{11} frequency curve equals the number of elements which z_{11} contains, the above statement is proven.

c. *Series resonance and shunt anti-resonance coincide if both are included in an internal transmitting band. Series and shunt anti-resonance coincide if both are included in an internal attenuating band.* This is a necessary relation in either case to preserve band confluency.

To ensure the necessary similarity between z_{11} and z_{1k} it will be assumed that for every series component in z_{1k} as above expressed there is one of proportional magnitude in z_{11} which latter may be written,

$$z_{11} = m_1 z_{a1} + m_2 z_{a2} + \dots + m_n z_{an}, \quad (14)$$

where the coefficients, m_1, \dots, m_n , are positive real numerics. From the formulae (11), (12), and (13) the shunt impedance becomes

$$z_{21} = \frac{R^2 + \frac{1}{4}(z_k^2 - z_{11}^2)}{z_{11}}. \quad (15)$$

If in this formula the assumed form (14) for z_{11} corresponding to any particular z_{1k} is substituted, it will be found that the resulting expression for z_{21} has exactly the requisite form to be the most general shunt impedance which that wave-filter may have. This therefore,

justifies the assumption regarding z_{11} and shows the latter to give *the general case* having the specified characteristic impedance.

The coefficients, m_1, \dots, m_n , may be evaluated by fixing any n physically realizable conditions such as n resonant frequencies of the shunt impedance, which are frequencies of infinite attenuation in the wave-filter. From the foregoing not more than two such frequencies may be included in any internal, and but one in any other, attenuating band. However, since the number of such conditions equals the number of attenuating bands it will be considered most useful to fix one resonant frequency in each attenuating band. If z_{11} has N elements, where $N=2n-2$, $2n-1$, or $2n$, the shunt impedance will have $2N$ which may then be found.

An evaluation process possible here is first to write the expression for z_{21} in (15) as the ratio of two polynomials with two variables, in which the assumed relation for z_{11} has been substituted and the variables are an arbitrarily chosen known inductive impedance, z_L , and capacitive impedance z_C , such, for example, as may occur in z_{1k} . Put each component of the desirable parallel resonant component form of z_{21} in terms of these same two variables and two undetermined coefficients, as $az_L + bz_C$, etc., and write the corresponding polynomial ratio expression for z_{21} which will involve the coefficients. A comparison of the two expressions for z_{21} which must be equivalent gives $2N$ relations between the coefficients m_1, \dots, m_n of z_{11} and the $2N$ coefficients a, b , etc., of z_{21} . Next fix n resonant frequencies of z_{21} , satisfying the relation

$$z_{21} = 0, \quad (16)$$

at frequencies $f_{1\infty}, \dots, f_{n\infty}$, one arbitrarily chosen in each attenuating band. These give n simple ratios $\frac{a}{b}$, etc., which with the other relations make a total of $2N+n$ simultaneous equations from which to determine the same number of coefficients. Their solution will give all coefficients explicitly in terms of the independent critical frequencies f, f_1, \dots , and frequencies of infinite attenuation $f_{1\infty}, \dots, f_{n\infty}$. It is more practical, however, to obtain such explicit solutions for the coefficients m_1, \dots, m_n only, and to express the coefficients a, b , etc., as functions of the frequencies and the m 's combined.

That the n additional conditions in (16) are the maximum number which can be imposed may be illustrated in the case of $n=2$ by the general low-band-and-high pass wave-filter of Fig. 3 corresponding to the "constant k " wave-filter of Fig. 2. This has a total of twelve elements per section which it will be seen are fully determined by

the following twelve conditions: four at the critical frequencies f_0, f_1, f_2 and f_3 , where $\frac{z_{11}}{4z_{21}} = -1$; four at frequencies f_{a1} and f_{a2} where both z_{11} and z_{21} are anti-resonant; one at a variable frequency in the internal transmitting band where z_{11} is resonant and z_{21} anti-resonant; one at

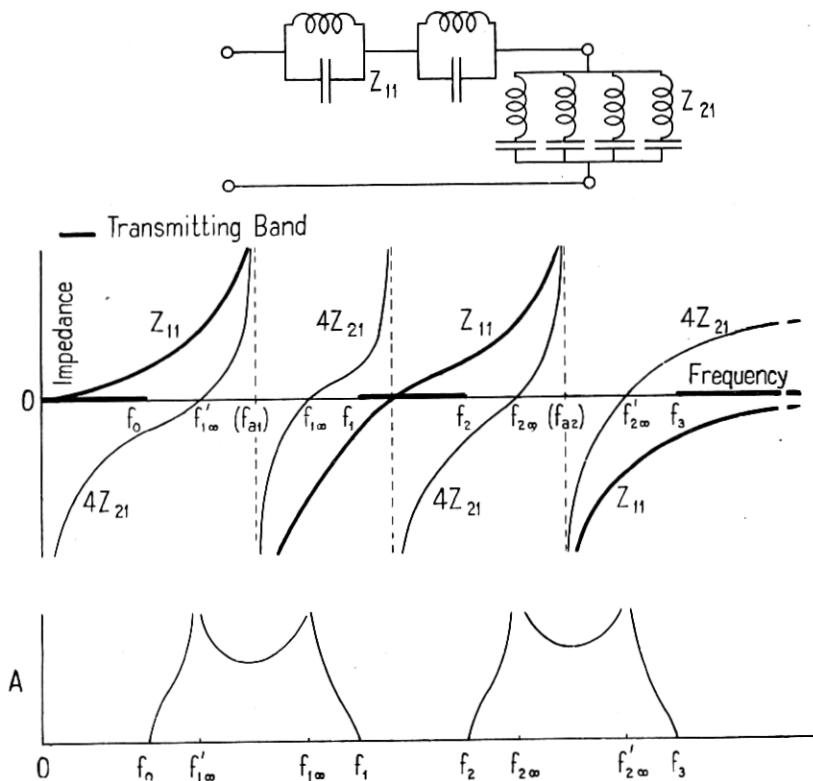

Fig. 3—General Mid-Series Equivalent Low-Band-and-High Pass Wave-Filter

one other frequency where the absolute value of the characteristic impedance is fixed; and two added conditions at the adjustable frequencies of infinite attenuation $f_{1\infty}$ and $f_{2\infty}$, bringing the total up to twelve.

In brief, the procedure for designing the general mid-series equivalent wave-filter is:

(1) Write down from the known "constant k " wave-filter having n preassigned attenuating bands the form of the series impedance with undetermined coefficients $m_1 \dots m_n$ as in (14).

(2) Obtain two expressions for the shunt impedance, one derived thru the characteristic impedance of the "constant k " wave-filter and containing the coefficients $m_1 \dots m_n$; the other from a consideration of its possible most general form corresponding to the series impedance, with coefficients a, b , etc. Equate these expressions at all frequencies and thus obtain a set of relations between the coefficients $m_1 \dots m_n$ and a, b , etc., equal to the latter in number.

(3) Fix one resonant frequency of the shunt impedance, a frequency of infinite attenuation, in each attenuating band, using the second expression above which will determine n simple ratios $\frac{a}{b}$, etc.

(4) Solve these simultaneous equations by obtaining an explicit solution for the coefficients m_1, \dots, m_n in terms of the critical frequencies $f_0, f_1 \dots$ and frequencies of infinite attenuation $f_{1\infty} \dots f_{n\infty}$, and a solution for the coefficients a, b , etc., in terms of these frequencies and the coefficients m_1, \dots, m_n .

This method will later be applied to the design of the low-and-band pass wave-filter.

Mid-Shunt Equivalent Wave-Filter

The general wave-filter whose mid-shunt characteristic impedance is equivalent to that of the "constant k " wave-filter can be obtained in a manner somewhat similar to the one above. However, it is possible to derive the mid-shunt equivalent directly from the mid-series equivalent wave-filter by a simple process wherein these two are assumed to have equivalent propagation constants.

Let the series and shunt impedances of this wave-filter be z_{12} and z_{22} , and its mid-series and mid-shunt characteristic impedances K_{12} and K_{22} , respectively. The fundamental condition here is that

$$K_{22} = K_{2k}. \quad (17)$$

Under the assumption that the wave-filter has a propagation constant equivalent to that of the general mid-series wave-filter, where $K_{11} = K_{1k}$, we may write from (1)

$$\frac{z_{11}}{z_{21}} = \frac{z_{12}}{z_{22}},$$

and

$$e^{-\Gamma} = \frac{2K_{1k} - z_{11}}{2K_{1k} + z_{11}} = \frac{2z_{22} - K_{2k}}{2z_{22} + K_{2k}}.$$

These relations and (1) give

$$z_{11}z_{22} = z_{12}z_{21} = K_{1k}K_{2k} = z_{1k}z_{2k} = R^2. \quad (18)$$

Hence, the general mid-shunt equivalent wave-filter can be obtained by designing its series and shunt impedances as inverse networks, of impedance product R^2 , to the shunt and series impedances, respectively, of the general mid-series equivalent wave-filter, under which conditions the two wave-filters have equivalent propagation constants.

To illustrate, a structure for the general mid-shunt equivalent low-band-and-high pass wave-filter corresponding to Figs. 2 and 3 is

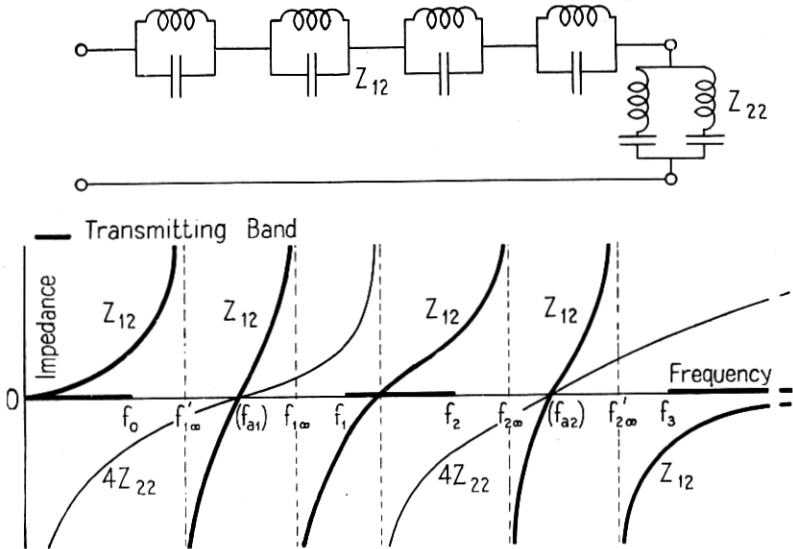

Fig. 4—General Mid-Shunt Equivalent Low-Band-and-High Pass Wave-Filter

shown in Fig. 4. The impedance diagram indicates how the transmitting and attenuating bands are produced. Here each anti-resonant component in the series impedance is responsible for one of the infinite attenuations shown in the equivalent attenuation diagram of Fig. 3. It may be seen also that when in practice it is necessary to balance the two sides of the line, the wave-filter of Fig. 4 requires more series balanced inductances and capacities than that of Fig. 3 to give an equivalent propagation constant. For this reason the mid-shunt equivalent wave-filter is usually not as economical as the mid-series equivalent wave-filter.

3. M-TYPE WAVE-FILTERS.

The term M-type will be applied to that case in each of the above general wave-filters in which the coefficients $m_1 \dots m_n$ coalesce to

the single value $m_1 = \dots = m_n = m$, leaving but one degree of freedom. They are of special interest because in wave-filters having many elements the impedances can be determined more directly than by the general methods above and, of greater importance, because the mid-shunt characteristic impedance, $K_{21}(m)$, of the mid-series equivalent M-type and the mid-series characteristic impedance, $K_{12}(m)$, of the mid-shunt equivalent M-type, both functions of m , can be made approximately a constant resistance over the greater part of every transmitting band, a desirable property.

In the mid-series equivalent M-type it follows from (14) and (15) that, since $z_{1k}z_{2k} = R^2$,

$$z_{11} = mz_{1k}, \quad (19)$$

and

$$z_{21} = \frac{1-m^2}{4m} z_{1k} + \frac{1}{m} z_{2k},$$

showing the shunt impedance to be expressible as a *series* combination of different proportions of the "constant k " series and shunt impedances. This structure is usually different from but equivalent to the mid-series equivalent wave-filter obtainable by the first method in which the m -coefficients are all equal to m . The value of the coefficient m is determined by fixing a resonant frequency of z_{21} , that is, any one frequency of infinite attenuation, f_∞ . From (19), for $(z_{21})_{f_\infty} = 0$,

$$m = \sqrt{1 + \left(\frac{4z_{2k}}{z_{1k}}\right)_{f_\infty}}. \quad (20)$$

The corresponding mid-shunt equivalent M-type having the same propagation constant follows from (18) with impedances

$$z_{12} = \frac{1}{\frac{1}{mz_{1k}} + \frac{1}{\frac{4m}{1-m^2}z_{2k}}}, \quad (21)$$

and

$$z_{22} = \frac{1}{m} z_{2k}.$$

Here the series impedance is expressible as a *parallel* combination of different proportions of the "constant k " impedances.²

² It is worth while to point out that from the nature of (19) and (21) these same relations result if z_{1k} and z_{2k} are the series and shunt impedances z_1 and z_2 of *any* ladder type recurrent network whatever. In order that there be a physically realizable structure corresponding to such general relations it is sufficient that $0 < m \leq 1$. A change of m will change the propagation constant without changing the mid-series characteristic impedance of the first network, and mid-shunt of the second.

The characteristic impedances, $K_{21}(m)$ and $K_{12}(m)$, follow from the substitution of (19) and (21) in (1), and are given by the relations

$$\frac{R}{K_{21}(m)} = \frac{K_{12}(m)}{R} = \frac{\sqrt{1 + \frac{z_{1k}}{4z_{2k}}}}{1 + \frac{(1-m^2)z_{1k}}{4z_{2k}}} \tag{22}$$

Fig. 5 shows graphically how this impedance ratio, neglecting dis-

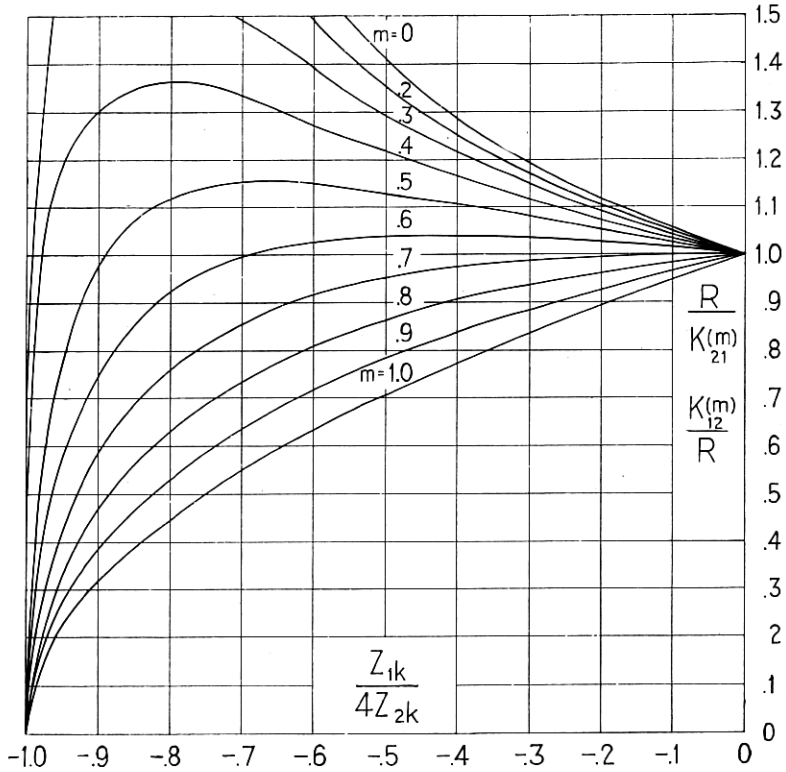

Fig. 5—M-Type Characteristic Impedances in Transmitting Band

sipation, depends upon m in any transmitting band. For the limiting values $m = 1$ and $m = 0$ it corresponds to $\frac{K_{1k}}{R}$ and $\frac{K_{2k}}{R}$, respectively.

For the intermediate value $m = .6$ it, and hence $K_{21}(m)$ and $K_{12}(m)$, is approximately constant over the greater part of the transmitting band thereby approaching the ideal sought. A wave-filter network having these latter terminations could then be connected between

constant resistance terminal impedances without introducing appreciable reflection losses at the important frequencies to be transmitted. It may also be added that where a number of wave-filters transmitting in different bands are to be joined in series or in parallel the usual terminations correspond to $K_{12}(m)$ and $K_{21}(m)$, respectively (where m is about .6), with the omission of the terminal half-series impedance in the first case and terminal double-shunt impedance in the second. In the transmitting band of any one of these wave-filters the rôle of the omitted impedance is approximately fulfilled

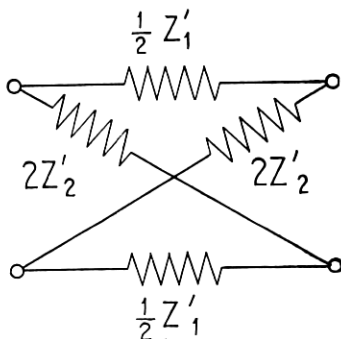

Fig. 6—Lattice Type Recurrent Network

by the resultant impedance of the other wave-filters. The approximation is very close when such connections are made with two complementary wave-filters having the same critical frequencies.

4. EQUIVALENT LATTICE TYPE WAVE-FILTERS.

The lattice type of recurrent network shown in Fig. 6 offers a simple example of a uniform type which can physically be made to have properties equivalent to those of the ladder type. Its formulae for propagation constant and characteristic impedance in terms of the series and lattice impedances, $\frac{1}{2}z'_1$ and $2z'_2$, are known to be

$$\cosh \Gamma' = 1 + \frac{2z'_1}{4z'_2 - z'_1}, \quad (23)$$

and

$$K' = \sqrt{z'_1 z'_2}.$$

A comparison of these formulae with those of the ladder type in (1) shows that when $\Gamma' = \Gamma$, and $K' = K_1$,

$$z'_1 = z_1, \quad (24)$$

and

$$z'_2 = \frac{1}{4}z_1 + z_2;$$

and that when $\Gamma' = \Gamma$, and $K' = K_2$,

$$z'_1 = \frac{1}{\frac{1}{z_1} + \frac{1}{4z_2}},$$

and $z'_2 = z_2$.

In both cases it is apparent that for equivalent results the lattice type requires more elements than the ladder type and is, therefore, not as economical.

PART II. DESIGN OF LOW-AND-BAND PASS WAVE-FILTERS AND REDUCTION TO WAVE-FILTERS OF LOWER CLASS

The foregoing theory of design can be applied separately to the design of wave-filters of each class in general use, which classes are the low pass, high pass, low-and-high pass, and band pass. However,

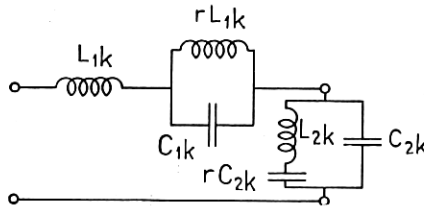

Fig. 7—"Constant k " Low-and-Band Pass Wave-Filter

instead of such individual treatment designs will first be derived for low-and-band pass wave-filters which are wave-filters of higher class than these four classes and include the latter as particular cases. The simplifications in structure and formulae which result upon their reduction to the lower classes will be considered later.

Low-and-Band Pass Wave-Filters

The structure of the "constant k " low-and-band pass wave-filter as derived from the attenuation requirements has the form of Fig. 7. Since this form may be obtained from that given in Fig. 2 by assuming the critical frequency, f_3 , in the latter to be infinite, we may under this assumption refer to Fig. 2 for the impedance and attenuation characteristics corresponding to Fig. 7.

The series impedance z_{1k} expressed as a function of frequency is

$$z_{1k} = i2\pi f L_{1k} \left(1 + \frac{r}{1 - 4\pi^2 f^2 r L_{1k} C_{1k}} \right), \quad (26)$$

where r is the ratio between the two inductances. The magnitudes of L_{1k} , C_{1k} and r are found from the conditions (7) which z_{1k} must satisfy at the critical frequencies f_0 , f_1 , and f_2 ; namely, $z_{1k} = +i2R$, $-i2R$, and $+i2R$. The resulting simultaneous equations become

$$\begin{aligned} f_0 w + f_0^2 x - f_0^3 y &= +1, \\ f_1 w - f_1^2 x - f_1^3 y &= -1, \end{aligned} \quad (27)$$

and

$$f_2 w + f_2^2 x - f_2^3 y = +1,$$

where $L_{1k} = \frac{yR}{\pi x}$; $C_{1k} = \frac{x^2}{4\pi R(wx - y)}$; and $r = \frac{wx}{y} - 1$.

The solution of (27) gives

$$L_{1k} = \frac{R}{\pi(f_0 - f_1 + f_2)}, \quad (28)$$

$$C_{1k} = \frac{(f_0 - f_1 + f_2)^2}{4\pi[(f_0 f_1 - f_0 f_2 + f_1 f_2)(f_0 - f_1 + f_2) - f_0 f_1 f_2]k},$$

and

$$r = (f_0 - f_1 + f_2) \left(\frac{1}{f_0} - \frac{1}{f_1} + \frac{1}{f_2} \right) - 1.$$

The corresponding shunt elements are obtained from the series elements by the inverse network relations, $\frac{L_{2k}}{C_{1k}} = \frac{L_{1k}}{C_{2k}} = R^2$, so that

$$L_{2k} = R^2 C_{1k}, \quad (29)$$

and

$$C_{2k} = \frac{L_{1k}}{R^2}.$$

With the "constant k " wave-filter elements so determined we shall now derive the series and shunt impedances, z_{11} and z_{21} , of the general mid-series equivalent wave-filter. Putting for convenience

$$z_L = i2\pi f L_{1k}, \text{ and } z_C = \frac{1}{i2\pi f C_{1k}},$$

formula (26) becomes

$$z_{1k} = z_L + \frac{r z_L z_C}{r z_L + z_C},$$

and

$$z_L z_C = r s R^2, \quad (30)$$

where

$$s = \frac{4f_0 f_1 f_2}{(f_0 - f_1 + f_2)^3}.$$

By (14) we may write for the general series impedance

$$z_{11} = m_1 z_L + \frac{m_2 r z_L z_C}{r z_L + z_C}, \quad (31)$$

in which the coefficients m_1 and m_2 are to be determined. Substitution of these relations in (15) gives one expression for the shunt impedance

$$z_{21} = \frac{\begin{cases} \frac{r^3 s}{4} (1 - m_1^2) z_L^2 + r^2 \left[1 + \frac{s}{2} (1 + r - m_1 (m_1 + m_2 r)) \right] z_L^2 z_C \\ + r \left[2 + \frac{s}{4} ((1 + r)^2 - (m_1 + m_2 r)^2) \right] z_L z_C^2 + z_C^3 \end{cases}}{m_1 r^3 s z_L^2 + r^2 s (2m_1 + m_2 r) z_L z_C + r s (m_1 + m_2 r) z_C^2}. \quad (32)$$

Also, since the series impedance has three elements, the most general structure for z_{21} is three resonant components in parallel. Letting these components be $az_L + bz_C$, $cz_L + dz_C$, and $ez_L + fz_C$, as in Fig. 8, the corresponding total impedance expression is

$$z_{21} = \frac{\frac{ace}{bdf} z_L^2 + \left(\frac{ac}{bd} + \frac{ae}{bf} + \frac{ce}{df} \right) z_L z_C + \left(\frac{a}{b} + \frac{c}{d} + \frac{e}{f} \right) z_L z_C^2 + z_C^3}{\frac{ac + ae + ce}{bdf} z_L^2 + \frac{a(d+f) + c(b+f) + e(b+d)}{bdf} z_L z_C + \left(\frac{1}{b} + \frac{1}{d} + \frac{1}{f} \right) z_C^2}. \quad (33)$$

Equality between (32) and (33) at all frequencies requires that the following relations be satisfied:

$$\begin{aligned} \frac{ace}{bdf} &= \frac{r^3 s}{4} (1 - m_1^2), \\ \frac{ac}{bd} + \frac{ae}{bf} + \frac{ce}{df} &= r^2 \left[1 + \frac{s}{2} (1 + r - m_1 (m_1 + m_2 r)) \right], \\ \frac{a}{b} + \frac{c}{d} + \frac{e}{f} &= r \left[2 + \frac{s}{4} ((1 + r)^2 - (m_1 + m_2 r)^2) \right], \\ \left(\frac{ce}{df} \right) \frac{1}{b} + \left(\frac{ae}{bf} \right) \frac{1}{d} + \left(\frac{ac}{bd} \right) \frac{1}{f} &= m_1 r^3 s, \end{aligned} \quad (34)$$

$$\left(\frac{c}{d} + \frac{e}{f} \right) \frac{1}{b} + \left(\frac{a}{b} + \frac{e}{f} \right) \frac{1}{d} + \left(\frac{a}{b} + \frac{c}{d} \right) \frac{1}{f} = r^2 s (2m_1 + m_2 r),$$

and
$$\frac{1}{b} + \frac{1}{d} + \frac{1}{f} = r s (m_1 + m_2 r),$$

where r and s are given in (28) and (30).

To fix one resonant frequency of z_{21} in each of the two attenuating bands, at $f_{1\infty}$ and $f_{2\infty}$, we may put

$$(az_L + bz_C)_{f_{1\infty}} = 0,$$

and

$$(cz_L + dz_C)_{f_{2\infty}} = 0,$$

which give finally

$$\frac{a}{b} = \frac{f_0 f_1 f_2}{(f_0 - f_1 + f_2) f_{1\infty}^2} r, \tag{35}$$

and

$$\frac{c}{d} = \frac{f_0 f_1 f_2}{(f_0 - f_1 + f_2) f_{2\infty}^2} r.$$

These eight simultaneous equations in (34) and (35) are sufficient to determine all the coefficients m_1 , m_2 , a , b , c , d , e , and f in terms of the critical frequencies f_0 , f_1 , and f_2 , and frequencies of infinite at-

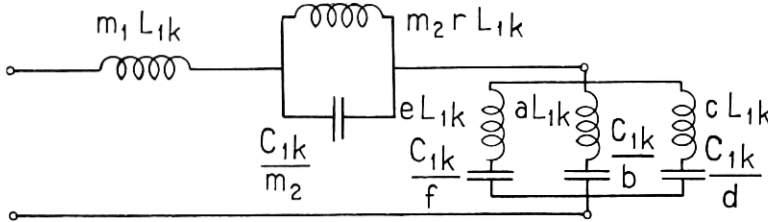

Fig. 8—General Mid-Series Equivalent Low-and-Band Pass Wave-Filter

tenuation, $f_{1\infty}$ and $f_{2\infty}$. The method of solution here used will be indicated only and the final results given in Appendix II. The combination of (35) and the first three equations of (34), makes it possible to eliminate all coefficients but m_1 and m_2 and to obtain formulae for the latter explicitly in terms of the frequencies. From (35) and the first equation and last three equations of (34), b , d , and f are calculable in terms of m_1 , m_2 , and the frequencies. These combined with (35) and the first equation of (34) furnish the values of a , c , and e . The formula for the dependent frequency of infinite attenuation, $f'_{1\infty}$, results from putting $(ez_L + fz_C)_{f'_{1\infty}} = 0$.

The general mid-shunt equivalent wave-filter, having impedances z_{12} and z_{22} , will be derived from the general mid-series equivalent wave-filter above through the inverse network relations of (18); namely, $z_{11}z_{22} = z_{12}z_{21} = R^2$. For the series impedance we have upon the substitution of z_{21}

$$z_{12} = \frac{R^2}{z_{21}} = \frac{R^2}{az_L + bz_C} + \frac{R^2}{cz_L + dz_C} + \frac{R^2}{ez_L + fz_C}. \tag{36}$$

Taking the first term of the right member as typical, it may be transformed through (29) to the form

$$\frac{R^2}{az_L + bz_C} = \frac{1}{\frac{az_L}{R^2} + \frac{bz_C}{R^2}} = \frac{1}{i2\pi faC_{2k} + \frac{1}{i2\pi f \frac{L_{2k}}{b}}}, \quad (37)$$

which is the impedance of an anti-resonant component having an inductance, $\frac{L_{2k}}{b}$, and a capacity, aC_{2k} . Similarly each of the other two terms of (36) represents the impedance due to an anti-resonant component, in one case of elements $\frac{L_{2k}}{d}$ and cC_{2k} , and in the other of elements $\frac{L_{2k}}{f}$ and eC_{2k} .

The shunt impedance may by (29) and (31) be put in the form

$$z_{22} = \frac{R^2}{z_{11}} = \frac{R^2}{m_1 z_L + m_2 r z_L z_C}, \quad (38)$$

$$= \frac{1}{i2\pi f m_1 C_{2k} + \frac{1}{i2\pi f \frac{L_{2k}}{m_2} + \frac{1}{i2\pi f m_2 r C_{2k}}}}$$

and is the impedance of a capacity $m_1 C_{2k}$ in parallel with a resonant component of inductance $\frac{L_{2k}}{m_2}$ and capacity $m_2 r C_{2k}$. The structure corresponding to z_{12} and z_{22} is shown in Fig. 9.

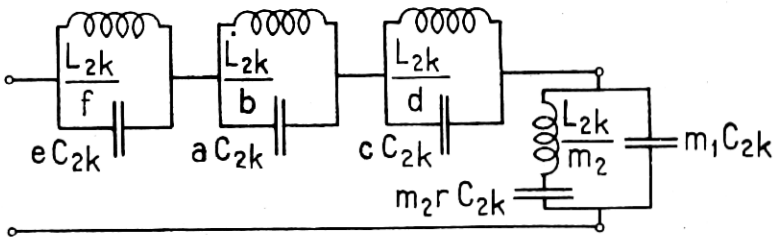

Fig. 9—General Mid-Shunt Equivalent Low-and-Band Pass Wave-Filter

The method of reducing these general wave-filters to the desired lower class wave-filters will now be taken up briefly. The resulting structures and formulae are given in Appendix II, where the two wave-filters having identical propagation constants are considered

together and are numbered. The subscripts $_1$ and $_2$ on these numbers refer, respectively, to the mid-series and mid-shunt equivalent wave-filters. The quantities with brackets occurring in some of the formulae are included merely to indicate the origin of their equivalents from the low-and-band pass wave-filters.

Low Pass Wave-Filters

These are some of the simplest wave-filters and are here obtained by considering

$$f_0 = f_{1\infty} = f_1 = 0. \quad (39)$$

In general these wave-filters have three elements per section and are identical with the M-types since there is but a single coefficient $m_1 = m$. The "constant k " structure, series inductance and shunt capacity, results when $f_{2\infty} = \infty$.

High Pass Wave-Filters

These wave-filters which are complementary to the low pass wave-filters also have simple structures, in general three elements per section, the M-types. To derive them assume in the general formulae

$$f_0 = 0, \quad (40)$$

and

$$f_2 = f_{2\infty} = \infty.$$

The additional condition, $f_{1\infty} = 0$, gives the "constant k " wave-filter of series capacity and shunt inductance.

Low-and-High Pass Wave-Filters

For the low-and-high pass transmission characteristic put

$$f_2 = f_{2\infty} = \infty. \quad (41)$$

Here some simplifications in notation may be made, as is indicated in the formulae by the quantities in brackets. The general structures, M-types, require six elements per section. A limiting case, the "constant k " wave-filter, having four elements per section, results when $f_{1\infty} = \sqrt{f_0 f_1} = f'_{1\infty}$.

Band Pass Wave-Filters

With the condition

$$f_0 = 0 \quad (42)$$

an internal transmitting band is retained and also the two independent frequencies of infinite attenuation, $f_{1\infty}$ and $f_{2\infty}$. Depending upon

the values of these frequencies, the wave-filter structures may have from three to six elements per section.

In the six element pair $f_{1\infty}$ and $f_{2\infty}$ are unrestricted except that they must lie within their respective attenuating bands. These wave-filters are the general ones including the others. A relation found to exist here is

$$\frac{1 - m_1^2}{1 - m_2^2} = \frac{f_1^2 f_2^2}{f_{1\infty}^2 f_{2\infty}^2}$$

which has been incorporated in the formulae. The three element structures, of which there are two pairs, come from putting $f_{1\infty} = 0$ and $f_{2\infty} = f_2$ in one case, $f_{1\infty} = f_1$ and $f_{2\infty} = \infty$ in the other. Those having four elements are the "constant k ," where $f_{1\infty} = 0$ and $f_{2\infty} = \infty$, and the two similar appearing pairs in one of which $f_{2\infty} = f_2$, and in the other $f_{1\infty} = f_1$. Two pairs of five element structures exist, one with $f_{1\infty} = 0$ and the other with $f_{2\infty} = \infty$. It is of interest to point out that $m_2 = 1$ in all of the band pass wave-filters where $f_{1\infty} = 0$, and $m_1 = 1$ where $f_{2\infty} = \infty$, showing that in these cases certain of the elements will be like those of the "constant k " wave-filter. Also, in the limiting cases where a frequency of infinite attenuation coincides with a critical frequency, the attenuation constant increases from zero at this frequency to a finite limiting value at the other extreme of the attenuating band.

The M-type band pass wave-filters are given by putting $m_1 = m_2 = m$. Choosing $f_{2\infty}$ as the independent frequency, the formulae simplify to

$$m = \frac{\sqrt{\left(1 - \frac{f_1^2}{f_{2\infty}^2}\right) \left(1 - \frac{f_2^2}{f_{2\infty}^2}\right)}}{1 - \frac{f_1 f_2}{f_{2\infty}^2}},$$

$$a = d = \frac{1 - m^2}{4m} \left(1 + \frac{f_{2\infty}^2}{f_1 f_2}\right),$$

$$b = c = \frac{1 - m^2}{4m} \left(1 + \frac{f_1 f_2}{f_{2\infty}^2}\right),$$

and

$$f_{1\infty} = \frac{f_1 f_2}{f_{2\infty}}.$$

PART III. COMPOSITE WAVE-FILTERS

The preceding parts of this paper have considered wave-filters as made up of a series of uniform sections. We know, however, from this discussion that the propagation constants of certain general

wave-filter sections can be changed without changing one of their mid-point characteristic impedances. Obviously then it should be possible to combine such sections so as to give a non-uniform network which introduces a number of different propagation constants.

The composite wave-filter is a network of serially connected wave-filter sections some or all of which are different in propagation constants, but adjacent sections of which are equivalent in characteristic impedance at their junction. The latter condition ensures the absence of impedance irregularities within the network. Consequently the composite wave-filter is specified by the sum of the propagation constants of the individual sections and the characteristic impedances of the end sections.

The advantage of composite over uniform wave-filters is in their flexibility of design by means of which it is easier and more economical to meet the attenuation and impedance requirements in many wave-filter networks. For example, to utilize the frequency range as completely as possible the attenuation of the network should in general rise rapidly upon entering the attenuating bands and remain high. It is also often desirable that the network have an approximately constant resistance terminal impedance in the transmitting bands. No uniform wave-filter possesses all these properties as it was found that the attenuation constant of any section varies markedly with frequency over the attenuating bands, being much higher in some parts than in others; then, too, the impedances of most wave-filters are not the best available. To give high attenuation at frequencies where the attenuation constant of a section is low requires a relatively large number of uniform sections and this means a surplus of attenuation at other frequencies. Aside from economic considerations this number is practically limited by the amount of attenuation introduced in the transmitting bands due to dissipation in the elements. In a composite wave-filter, however, it is possible to distribute the low and high attenuations of the individual sections over the frequency bands so that an efficient use is made of these attenuation properties and a more uniform high attenuation is produced; a desirable impedance characteristic is obtainable by M-type section terminations.

In the case of ladder types, for example, we may look upon the composite wave-filter as having been originally a number of sections of the general mid-series or mid-shunt equivalent wave-filters wherein now the propagation constants of the sections have been changed without changing their characteristic impedances. The mid-series and mid-shunt wave-filters may also both be included since their junction can be made through the intermediate use of the "constant

k'' wave-filter, a half-section being the minimum. Again, mid-series and mid-shunt sections derived from prototypes other than the "constant k " wave-filter, such as have already been indicated in connection with the generalized M-type formulae, are other possible units. The two different half-series impedances which join where two mid-series sections are connected together can always be merged into one impedance having the same impedance structure but in general different magnitudes for all elements; a similar merging of shunt impedances can be effected at the junction of two mid-shunt sections. It is here from a structural standpoint that the ladder type is much superior to other types, such as the lattice type over which it has the additional advantage of a smaller number of elements per section. For if one or more sections of the lattice type are included in the composite network each section must be completely constructed since there is no possibility of merging adjacent impedances.

It is known that among band pass wave-filters having equivalent mid-point characteristic impedances some have positive phase constants and others negative at the same frequencies in the transmitting band. The question may be raised as to whether such sections can not be combined in a manner which will give zero phase in addition to zero attenuation throughout the transmitting band. The impossibility of this follows directly from the phase constant theorem previously given, namely, that the phase constant increases with frequency throughout the transmitting band, irrespective of its sign. Combining sections increases the rate of total phase change with frequency.

Equivalent Substitutions

There are equivalent structures for certain wave-filter sections as well as for many of their impedances and impedance combinations. This is of practical importance in design where it is sometimes advantageous to use one form in preference to another. The number of elements, their magnitudes, or both, are some of the determining factors in this choice.

The wave-filter sections here considered are of the band pass class and their equivalence relations, both as regards current propagation and impedance, are given by the following tabulation in which these wave-filters are referred to by number as in Appendix II. The subscripts ₁ and ₂ are omitted since it is to be understood that the relations apply on the one hand to mid-series sections having those numbers with a subscript ₁ and on the other to mid-shunt sections

numbered correspondingly with a subscript 2. We have then for mid-series or mid-shunt sections:

$$\begin{aligned}
 (a) \quad IV &\equiv VIII + IX, \\
 (b) \quad VII &\equiv V + VI, \\
 (c) \quad X &\equiv V + IX, \\
 (d) \quad XI &\equiv VI + VIII,
 \end{aligned} \tag{44}$$

whence it follows that

$$(e) \quad IV + VII \equiv X + XI,$$

etc. To verify these identities we need to consider the propagation constants only since impedance equivalence is known to exist. This is most easily accomplished in either the mid-series or mid-shunt cases by using the formula for $e^{-\Gamma}$ in (1) to show the sufficient relation for propagation constant equivalence,

$$e^{-\Gamma} = e^{-\Gamma'} e^{-\Gamma''}. \tag{45}$$

Here Γ represents the propagation constant of the section in the left-hand member of (44) $a, b, c,$ or d ; Γ' and Γ'' those of the corresponding right-hand member sections. It can likewise be verified that these identities hold even when dissipation is present if in both structures all inductances have the same time constants and if a similar relation holds for all capacities. A comparison shows that the numbers of elements in the two structures corresponding to the left- and right-hand members of (44) are, respectively, 8 and 10 in (a), 6 and 8 in (b), 7 and 9 in both (c) and (d), and 12 and 12 in (e).

Equivalent impedance structures involving two inductances and two capacities have already been mentioned in the discussion of the "constant k " low-band-and-high pass wave-filter in Part I. These also include equivalent three element structures. The formulae which hold when a transformation is made from one structure to an equivalent one follow directly from those for certain combinations of two different general impedance components, as given in Appendix III. Because of this generality of the components, equivalence exists even when there is dissipation provided the inductances and capacities have time constants which are, respectively, the same in all. Moreover, since the two structures are identical from an impedance standpoint at all frequencies of the steady periodic state, they will be identical similarly under any conditions of the transient state. The method of deriving the formulae consists in first forming for the two corresponding networks their general impedance expressions which are found to have the same functional form in the two com-

ponents and differ only in the constant factors involving the network parameters. These corresponding factors in the two expressions are then equated to make the two impedances identical at all frequencies and it is this set of equations which leads to the relations between the parameters of the two networks. The list of structures given in Appendix III covers the usual transformations in practice and could be extended by adding more and more elements.

Among other types of possible substitutions are obviously those involving a change from three star-connected (T) to three delta-connected (Π) similar impedances, or vice versa, and from three star- or delta-connected inductances to a transformer with mutual impedance. As a simple illustration consider the mid-series band pass wave-filter VI_1 having series inductance and capacity and shunt capacity which can be put in the form of series inductances connecting a series of three star-connected capacities. Changing these capacities into the delta form gives a recurrent structure in which inductances alternate with capacities for the series impedances and capacities form the shunt impedances. Similarly V_1 may be changed to a structure in which inductances alternate with capacities for the series impedances and inductances form the shunt impedances. Another structure for the latter is a series of transformers connected by series capacities.

Composite Band Pass Wave-Filter Illustration

A band pass wave-filter has been chosen to show what can be accomplished by means of a composite structure towards realizing the ideal of attenuation and impedance characteristics. The transmitting band and impedance are specified by

$$f_1 = 4,000 \text{ } \omega,$$

$$f_2 = 7,000 \text{ } \omega,$$

and

$$R = 600 \text{ ohms.}$$

The sections arbitrarily taken to make up the structure are one each of the following:

$$IV_1, \text{ M-type, } m = .6, (f_{1\infty} = 3739 \text{ } \omega, f_{2\infty} = 7489 \text{ } \omega),$$

$$X_1, f_{2\infty} = 8300 \text{ } \omega,$$

and

$$XI_1, f_{1\infty} = 3300 \text{ } \omega,$$

where a half section of the M-type is placed at each end so as to give the network a symmetrical terminal characteristic impedance of

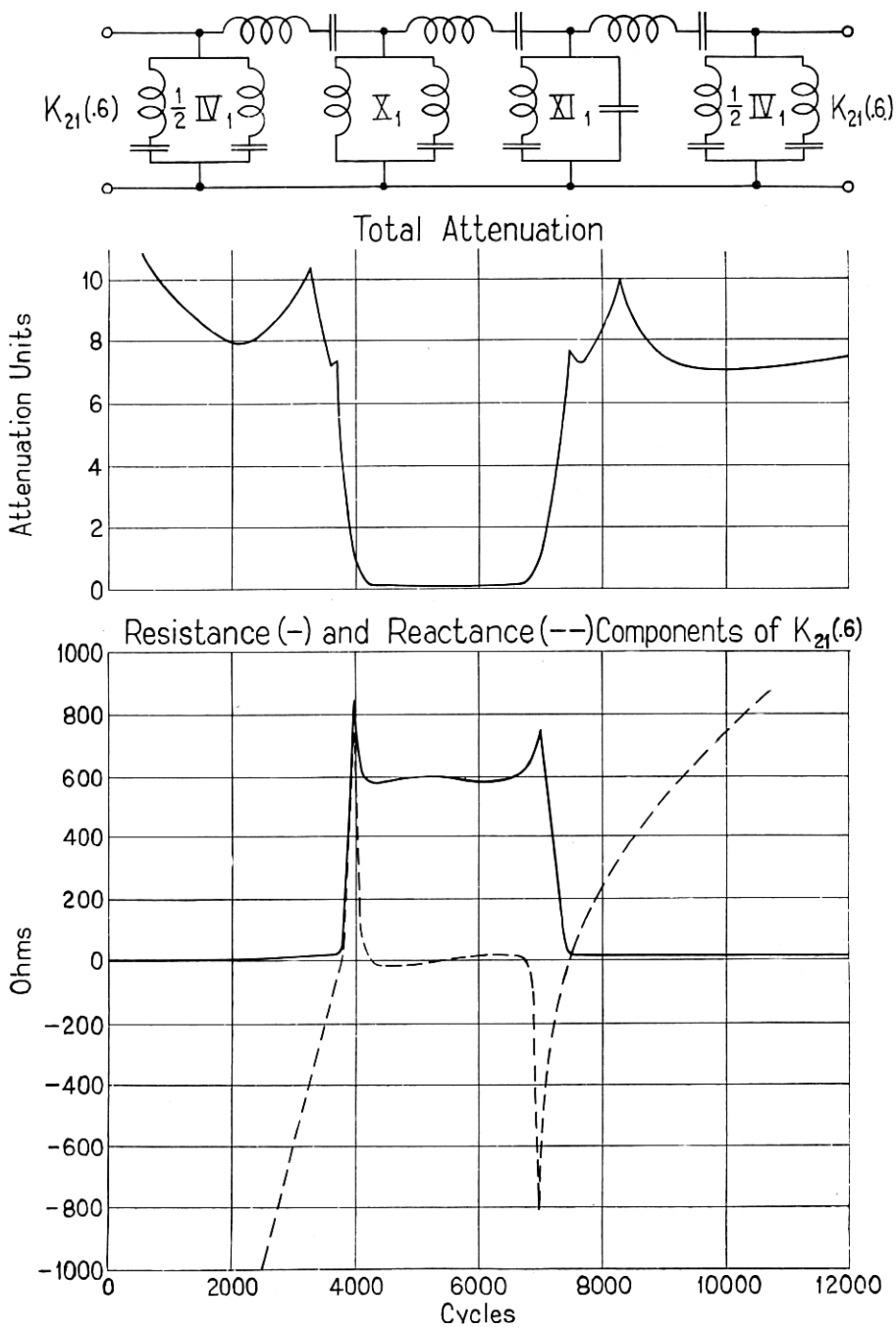

Fig. 10—Composite Band Pass Wave-Filter.

$K_{21}(m=.6)$, as in Fig. 10. Dissipation in the inductances is included by assuming effective coil resistance = $\frac{1}{100}$ coil reactance; it has the effect of eliminating abrupt changes in the attenuation and impedance characteristics. Computations made on this basis give the sum of the three attenuation constants and the impedance $K_{21}(.6)$ as shown in the figure.

The attenuation over a range of 2500 cycles about the center of the transmitting band is less than .19 attenuation units and for frequencies in the attenuating band is high, remaining after the first maximum on either side of the transmitting band above a value 7.30 in the lower frequency attenuating band and a value 7.10 in the upper. The characteristic impedance $K_{21}(.6)$ over the 2500 cycle range is everywhere within 3% of the desired resistance value, 600 ohms, and has here a negligible reactance. Its resistance component has maxima at the critical frequencies and decreases rapidly to small values in both attenuating bands. The reactance component is negative like a capacity reactance at very low frequencies, has a positive maximum at the lower critical frequency and negative minimum at the upper critical frequency, and is positive like an inductive reactance at very high frequencies. This demonstrates the possibilities of the composite structure method.

APPENDIX I

DERIVATION OF FUNDAMENTAL FORMULAE

Although formulae for the propagation constant and characteristic impedances of the 'adder type of recurrent network are well known and follow readily from a consideration of the current and voltage relations shown in Fig. 1, it is perhaps of interest to derive them as a special case of general formulae which involve admittances³ and which are directly applicable to any type of recurrent passive structure including loaded lines.

Let the periodic section of the recurrent structure be defined by the one-point and two-point admittances A_{aa} , A_{bb} , and A_{ab} , where the subscripts a and b , respectively, refer to its two pairs of terminals. Then the current at the junction, q , in terms of the voltages at the junctions $q-1$, q , and $q+1$, is

$$I_q = A_{ab}V_{q-1} - A_{bb}V_q = A_{aa}V_q - A_{ab}V_{q+1}, \quad (1)$$

³ The solution by Difference Equations in terms of the admittances was suggested by J. R. Carson and is a convenient form for expressing the general results.

whence

$$(A_{aa} + A_{bb})V_q - A_{ab}(V_{q-1} + V_{q+1}) = 0 \quad (2)$$

which is the Difference Equation of Propagation.

Letting

$$V_q = Me^{-q\Gamma} + Ne^{q\Gamma}, \quad (3)$$

equation (2) becomes

$$(A_{aa} + A_{bb} - 2A_{ab} \cosh \Gamma) V_q = 0$$

which gives, for all values of V_q ,

$$\cosh \Gamma = \frac{A_{aa} + A_{bb}}{2A_{ab}}.$$

Since equations (1) when combined give

$$I_q = \frac{1}{2}(A_{aa} - A_{bb})V_q + \frac{1}{2}A_{ab}(V_{q-1} - V_{q+1}),$$

we have upon the substitution of (3)

$$I_q = \frac{1}{K_a} Me^{-q\Gamma} - \frac{1}{K_b} Ne^{q\Gamma},$$

wherein the characteristic impedances K_a and K_b , as defined by the equation, are

$$\left. \begin{array}{l} \frac{1}{K_a} \\ 1 \\ \frac{1}{K_b} \end{array} \right\} = A_{ab} \sinh \Gamma \pm \frac{1}{2}(A_{aa} - A_{bb}).$$

In terms of the admittances then

$$\cosh \Gamma = \frac{A_{aa} + A_{bb}}{2A_{ab}},$$

and

$$\left. \begin{array}{l} K_a \\ K_b \end{array} \right\} = \frac{1}{2} \left(\frac{A_{aa} + A_{bb}}{A_{aa}A_{bb} - A_{ab}^2} \right) \left\{ \sqrt{1 - \left(\frac{2A_{ab}}{A_{aa} + A_{bb}} \right)^2} \mp \left(\frac{A_{aa} - A_{bb}}{A_{aa} + A_{bb}} \right) \right\}. \quad (4)$$

These formulae can readily be expressed in terms of the impedances Z_{aa} , Z_{bb} , and Z_{ab} ; or in terms of the three star-connected (T) or three delta-connected (Π) impedances which may represent the section.

Another general formula for the propagation constant which is sometimes convenient may be derived as follows. Assume that the recurrent structure is open-circuited at the junction q ; then in (1) $I_q = 0$, so that

$$\frac{V_{q-1}}{V_q} = \frac{A_{bb}}{A_{ab}} = \frac{1}{v_{ab}},$$

and

$$\frac{V_{q+1}}{V_q} = \frac{A_{aa}}{A_{ab}} = \frac{1}{v_{ba}},$$

in which v_{ab} and v_{ba} represent the transfer voltage ratios, taken in the two directions, of an open-circuited section. By (4) we find that

$$\cosh \Gamma = \frac{1}{2} \left(\frac{1}{v_{ab}} + \frac{1}{v_{ba}} \right). \quad (5)$$

Hence, *the hyperbolic cosine of the propagation constant in a section of any recurrent network is the arithmetic mean of the reciprocals of the two transfer voltage ratios of an open-circuited section.*

For a symmetrically terminated section

$$A_{aa} = A_{bb} = A_o,$$

$$A_{ab} = A_T,$$

$$K_a = K_b = K,$$

and

$$v_{ab} = v_{ba} = v_T.$$

Hence,

$$\cosh \Gamma = \frac{A_o}{A_T} = \frac{1}{v_T}, \quad (6)$$

and

$$K = \frac{1}{A_o \sqrt{1 - \left(\frac{A_T}{A_o}\right)^2}} = \frac{1}{A_o \sqrt{1 - v_T^2}}.$$

In the ladder type of Fig. 1 consider first a mid-series section. For this

$$A_o = \frac{\frac{1}{2}z_1 + z_2}{z_1z_2 + \frac{1}{4}z_1^2},$$

$$A_T = \frac{z_2}{z_1z_2 + \frac{1}{4}z_1^2}.$$

Then

$$\cosh \Gamma = 1 + \frac{1}{2} \frac{z_1}{z_2}, \quad (7)$$

and

$$K_1 = \sqrt{z_1z_2 + \frac{1}{4}z_1^2}.$$

For a mid-shunt section

$$A_o = \frac{z_1 + 2z_2}{2z_1z_2},$$

and

$$A_T = \frac{1}{z_1},$$

giving necessarily the same propagation constant formula as in (7) and

$$K_2 = \frac{z_1 z_2}{\sqrt{z_1 z_2 + \frac{1}{4} z_1^2}} = \frac{z_1 z_2}{K_1} \quad (8)$$

The two formulae

$$e^{-\Gamma} = \frac{2K_1 - z_1}{2K_1 + z_1} = \frac{2z_2 - K_2}{2z_2 + K_2} \quad (9)$$

may be verified by substitution in (7) and (8).

In the lattice type of Fig. 6 the admittances are

$$A_o = \frac{z_1' + 4z_2'}{4z_1' z_2'}$$

and

$$A_T = \frac{4z_2' - z_1'}{4z_1' z_2'}$$

which lead simply to formulae

$$\cosh \Gamma' = 1 + \frac{2z_1'}{4z_2' - z_1'} \quad (10)$$

and

$$K' = \sqrt{z_1' z_2'}$$

PROPERTIES OF REACTANCES

The first half of Theorem 1 on non-dissipative reactance networks, stated in Part I and relating to the positive slope of reactance with frequency, can be shown easily by the method of induction where the reactance network is the usual case of series and parallel combinations of inductances and capacities, considered as non-dissipative. Let z' and z'' be two impedances, and let z_S and z_P be the impedances of their combinations in series and in parallel, respectively. It follows that their derivatives with respect to frequency have the relations

$$\begin{aligned} \frac{dz_S}{df} &= \frac{dz'}{df} + \frac{dz''}{df}, \\ \frac{dz_P}{df} &= \frac{1}{\left(1 + \frac{z'}{z''}\right)^2} \frac{dz'}{df} + \frac{1}{\left(1 + \frac{z''}{z'}\right)^2} \frac{dz''}{df}. \end{aligned} \quad (11)$$

These show that if z' and z'' are reactances having positive slopes with frequency, z_S and z_P will also have positive slopes. Beginning then with the two simplest elements known to have positive reactance slopes, a single inductance and a single capacity, we may combine them and add others in any series and parallel combinations with

the result of a positive total reactance slope in every case, due to the above relations. That this property is not limited to such combinations is seen from the general impedance expression for a non-dissipative reactance network,⁴

$$z = iM \frac{f(f_2^2 - f^2) \dots (f_{2n}^2 - f^2)^u}{(f_1^2 - f^2) \dots (f_{2n-1}^2 - f^2)} \quad (12)$$

Here M is a positive real, and the resonant and anti-resonant frequencies, $f_1 \dots f_{2n}$, alternate and are in the order of increasing magnitude. The exponent, u , is unity or zero according as a resonant or an anti-resonant frequency is the last of the series. Assuming without loss of generality that f_1 is not zero, the reactance increases with frequency from zero frequency up to $f=f_1$, since all the factors are positive. As f passes thru this anti-resonant frequency the reactance changes abruptly from positive to negative infinity and when f increases to the resonant frequency f_2 the negative reactance increases to zero. As f increases beyond the value f_2 the reactance is again positive and the cycle of reactance changes with frequency begins over again.

The possibility of representing such a general reactance identically at all frequencies by a network constructed of either a number of simple resonant components in parallel, or simple anti-resonant components in series, follows from the fact that in any particular case the number of inductances and capacities involved is always equal to the total number of conditions which this network must satisfy to obtain such equality. Thus, its reactance must be zero and infinite at the given resonant and anti-resonant frequencies, respectively, and must have a definite magnitude at some one other frequency, which conditions are sufficient to determine all the impedance elements. In general, other equivalent combinations of inductances and capacities are also possible.

Theorem 2, relating to inverse networks, will be proved by an inductive method in which the given reactance network is assumed to have the form of series and parallel combinations of inductances and capacities, a form which by the first theorem can be taken to represent the reactance of any non-dissipative reactance network. Let z'_1 and z'_2 be one pair of impedances which are inverse networks of impedance product D^2 to each other, and let z''_1 and z''_2 be another pair so that

$$z'_1 z'_2 = z''_1 z''_2 = D^2 = \text{a constant positive real.}$$

Then z'_1 and z''_1 in series, and z'_2 and z''_2 in parallel are a pair of inverse

⁴ See paper by G. A. Campbell, Vol. I, No. 2, p. 30, this Journal.

networks of impedance product D^2 . This is readily shown, for here we have

$$(z_1' + z_1'') \left(\frac{z_2' z_2''}{z_2' + z_2''} \right) = \frac{(z_1'' z_2'') z_2' + (z_1' z_2') z_2''}{z_2' + z_2''} = D^2.$$

Similarly z_1' and z_1'' in parallel, and z_2' and z_2'' in series are another pair of impedance product D^2 .

The simplest pair of inverse networks in the case of reactances is an inductance and a capacity. If in an elementary application of the above relations the element L_1' corresponds to z_1' , C_2' to z_2' , C_1'' to z_1'' , and L_2'' to z_2'' , where then

$$\frac{L_1'}{C_2'} = \frac{L_2''}{C_1''} = D^2, \quad (13)$$

it follows that L_1' and C_1'' in series or in parallel, and L_2'' and C_2' in parallel or in series, respectively, are inverse networks of impedance product D^2 . By successive applications of these relations we may construct any given reactance and its inverse network.

It should be mentioned that these inverse network relations are even more general than has been considered above, for an elemental pair of inverse networks, besides an inductance and a capacity, is two resistances.

PHASE CONSTANT

To show that the phase constant increases with frequency throughout each transmitting band of a wave-filter, we may proceed as follows, basing the proof primarily upon the fact that the slopes with frequency of non-dissipative reactances are positive. Consider a mid-series section of the ladder type z_1, z_2 . The impedances as measured across one pair of terminals when the other pair is open or short-circuited are, respectively,

$$Z_o = \frac{1}{2}z_1 + z_2,$$

and

$$Z_s = \frac{1}{2}z_1 + \frac{z_1 z_2}{z_1 + 2z_2},$$

whose derivatives with respect to frequency may be written

$$\frac{dZ_o}{df} = i s^2, \text{ and } \frac{dZ_s}{df} = i t^2,$$

where s^2 and t^2 represent essentially positive quantities in accordance with the above underlying fact.

The general propagation constant formula is

$$\begin{aligned} \cosh (A+i B) &= \cosh A \cos B+i \sinh A \sin B, \\ &= 1+\frac{1}{2} \frac{z_1}{z_2}=1+\frac{1}{2} \frac{r_1+i x_1}{r_2+i x_2}, \\ &= \frac{r_2\left(r_1+2 r_2\right)+x_2\left(x_1+2 x_2\right)}{2\left(r_2^2+x_2^2\right)}+i \frac{\left(r_2 x_1-r_1 x_2\right)}{2\left(r_2^2+x_2^2\right)}; \end{aligned} \quad (14)$$

r_1 , r_2 and x_1 , x_2 being the resistance and reactance components of the two impedances, z_1 and z_2 .

In the transmitting bands of non-dissipative wave-filters where $r_1=r_2=0$, the formula becomes

$$\cos B=1+\frac{1}{2} \frac{x_1}{x_2}.$$

Differentiating this equation and introducing the above facts, we obtain for the rate of change of the phase constant with frequency

$$\frac{dB}{df}=\frac{(1-\cos B)}{x_1 \sin B}\left(s^2 \sin ^2 B+t^2 \cos ^2 B\right). \quad (15)$$

This rate obviously has the same sign as the denominator which we shall show is positive. For, the non-dissipative wave-filter being considered as the limiting case of one having small positive dissipation, we may temporarily return to the general propagation constant relations (14) in which r_1 and r_2 are assumed to be positive infinitesimals. Then in the limit when $r_1=r_2=0$, since also x_1 and x_2 are of opposite signs in any transmitting band, it follows that x_1 and $\sin B$ are of the same sign and that their product is positive.

APPENDIX II.

I.—GENERAL LOW PASS WAVE-FILTERS OF LADDER TYPE

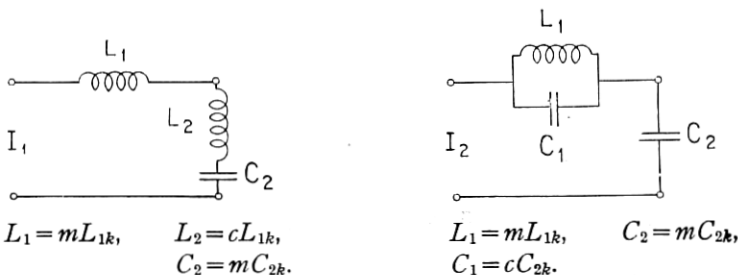

$$L_1 = mL_{1k}, \quad L_2 = cL_{1k}, \quad C_2 = mC_{2k},$$

$$L_1 = mL_{1k}, \quad C_1 = cC_{2k}, \quad C_2 = mC_{2k},$$

$$L_{1k} = \frac{R}{\pi f_2}, \quad C_{2k} = \frac{1}{\pi f_2 R},$$

$$m \equiv [m_1] = \sqrt{1 - \frac{f_2^2}{f_{2\infty}^2}}, \quad c = \frac{1 - m^2}{4m}.$$

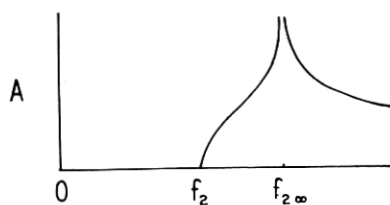

II.—GENERAL HIGH PASS WAVE-FILTERS OF LADDER TYPE

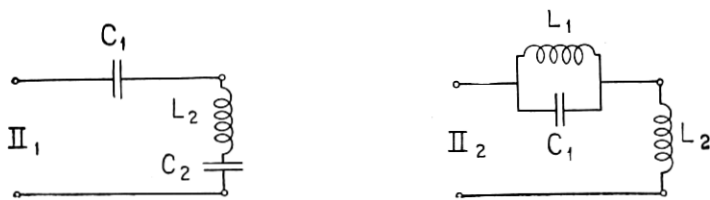

$$C_1 = \frac{C_{1k}}{m}, \quad L_2 = \frac{L_{2k}}{m}, \quad C_2 = \frac{C_{1k}}{b},$$

$$L_1 = \frac{L_{2k}}{b}, \quad L_2 = \frac{L_{2k}}{m}, \quad C_1 = \frac{C_{1k}}{m}.$$

$$C_{1k} = \frac{1}{4\pi f_1 R}, \quad L_{2k} = \frac{R}{4\pi f_1},$$

$$m \equiv [m_2] = \sqrt{1 - \frac{f_{1\infty}^2}{f_1^2}}, \quad b = \frac{1 - m^2}{4m}.$$

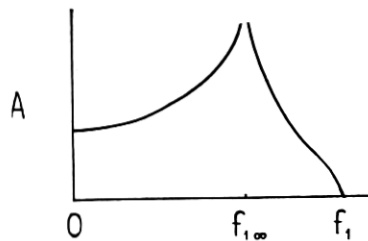

III. GENERAL LOW-AND-HIGH PASS WAVE-FILTERS OF LADDER TYPE

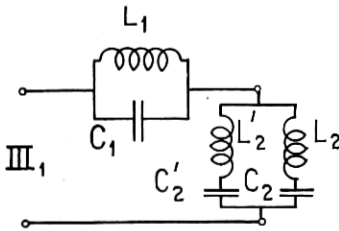

$$L_1 = mL'_{1k}, \quad L_2 = a'L_{2k},$$

$$C_1 = \frac{C_{1k}}{m}, \quad C_2 = \frac{C'_{2k}}{b'},$$

$$L_2' = e'L_{2k},$$

$$C_2' = \frac{C'_{2k}}{f'}.$$

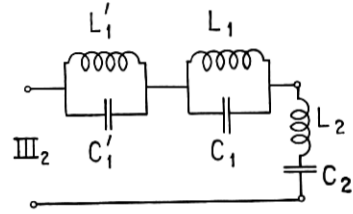

$$L_1 = \frac{L_{1k}}{b'}, \quad L_2 = \frac{L_{2k}}{m},$$

$$C_1 = a'C_{1k}, \quad C_2 = mC'_{2k},$$

$$L_1' = \frac{L_{1k}}{f'},$$

$$C_1' = e'C_{1k}.$$

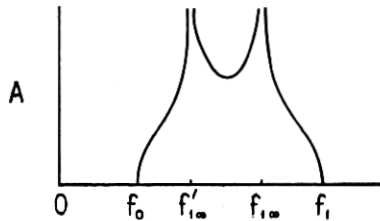

$$L'_{1k} \equiv [rL_{1k}] = \frac{(f_1 - f_0)R}{\pi f_0 f_1}, \quad L_{2k} = \frac{R}{4\pi(f_1 - f_0)},$$

$$C_{1k} = \frac{1}{4\pi(f_1 - f_0)R}, \quad C'_{2k} \equiv [rC_{2k}] = \frac{f_1 - f_0}{\pi f_0 f_1 R},$$

$$m \equiv [m_2] = \frac{\sqrt{\left(1 - \frac{f_0^2}{f_{1\infty}^2}\right) \left(1 - \frac{f_{1\infty}^2}{f_1^2}\right)}}{1 - \frac{f_0}{f_1}},$$

$$a' \equiv \left[\frac{4a(f_1 - f_0)^2}{rf_0 f_1} \right] = \frac{1}{m} \left(1 + \frac{f_0 f_1}{f_{1\infty}^2} \right) = \left[\frac{4f(f_1 - f_0)^2}{f_0 f_1} \right] \equiv f',$$

$$b' \equiv \left[\frac{4b(f_1 - f_0)^2}{f_0 f_1} \right] = \frac{1}{m} \left(1 + \frac{f_{1\infty}^2}{f_0 f_1} \right) = \left[\frac{4e(f_1 - f_0)^2}{rf_0 f_1} \right] \equiv e',$$

$$f'_{1\infty} = \frac{f_0 f_1}{f_{1\infty}}.$$

IV. GENERAL BAND PASS WAVE-FILTERS OF LADDER TYPE
Six Element Structures

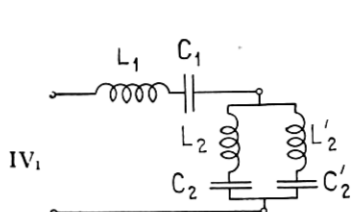

$$L_1 = m_1 L_{1k}, \quad L_2 = a L_{1k},$$

$$C_1 = \frac{C_{1k}}{m_2}, \quad C_2 = \frac{C_{1k}}{b},$$

$$L'_2 = c L_{1k}, \quad C'_2 = \frac{C_{1k}}{d}.$$

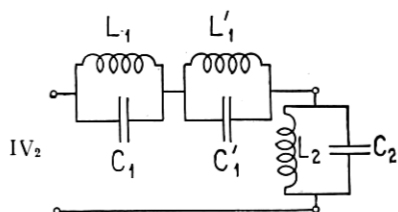

$$L_1 = \frac{L_{2k}}{b}, \quad L_2 = \frac{L_{2k}}{m_2},$$

$$C_1 = a C_{2k}, \quad C_2 = m_1 C_{2k},$$

$$L'_1 = \frac{L_{2k}}{d}, \quad C'_1 = c C_{2k}.$$

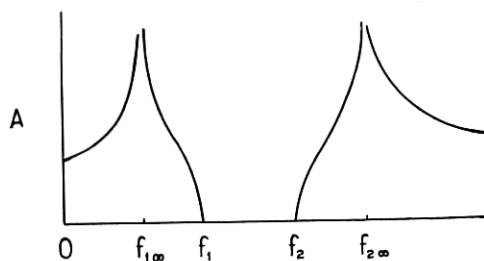

$$L_{1k} = \frac{R}{\pi(f_2 - f_1)}, \quad L_{2k} = \frac{(f_2 - f_1)R}{4\pi f_1 f_2},$$

$$C_{1k} = \frac{f_2 - f_1}{4\pi f_1 f_2 R}, \quad C_{2k} = \frac{1}{\pi(f_2 - f_1)R},$$

$$g = \sqrt{\left(1 - \frac{f_{1\infty}^2}{f_1^2}\right) \left(1 - \frac{f_{1\infty}^2}{f_2^2}\right)}, \quad h = \sqrt{\left(1 - \frac{f_{1\infty}^2}{f_2^2}\right) \left(1 - \frac{f_{2\infty}^2}{f_2^2}\right)},$$

$$m_1 = \frac{\frac{f_1 f_2}{f_{2\infty}^2} g + h}{1 - \frac{f_{1\infty}^2}{f_{2\infty}^2}}, \quad m_2 = \frac{g + \frac{f_{1\infty}^2}{f_1 f_2} h}{1 - \frac{f_{1\infty}^2}{f_{2\infty}^2}},$$

$$a = \frac{(1 - m_1^2) f_{2\infty}^2}{4g f_1 f_2} \left(1 - \frac{f_{1\infty}^2}{f_{2\infty}^2}\right) = \frac{(1 - m_2^2) f_1 f_2}{4g f_{1\infty}^2} \left(1 - \frac{f_{1\infty}^2}{f_{2\infty}^2}\right),$$

$$b = \frac{(1 - m_2^2)}{4g} \left(1 - \frac{f_{1\infty}^2}{f_{2\infty}^2}\right),$$

$$c = \frac{(1 - m_1^2)}{4h} \left(1 - \frac{f_{1\infty}^2}{f_{2\infty}^2}\right),$$

$$d = \frac{(1 - m_1^2) f_{2\infty}^2}{4h f_1 f_2} \left(1 - \frac{f_{1\infty}^2}{f_{2\infty}^2}\right) = \frac{(1 - m_2^2) f_1 f_2}{4h f_{1\infty}^2} \left(1 - \frac{f_{1\infty}^2}{f_{2\infty}^2}\right).$$

M-types: $m = m_1 = m_2 = \frac{h}{1 - \frac{f_1 f_2}{f_{2\infty}^2}}, \quad f_{1\infty} = \frac{f_1 f_2}{f_{2\infty}}, \quad g = h.$

BAND PASS WAVE-FILTERS OF LADDER TYPE

Three Element Structures

V. $f_{1\infty} = 0, f_{2\infty} = f_2.$

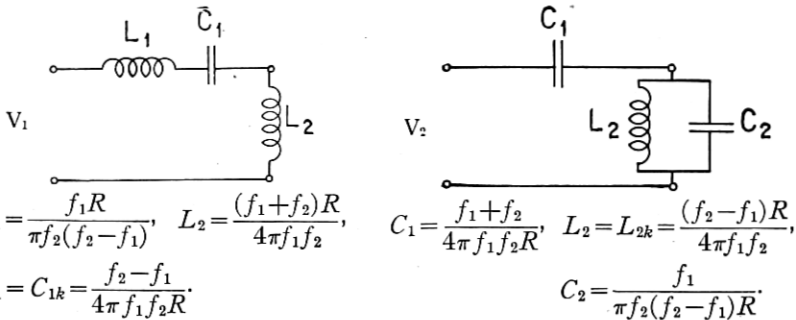

VI. $f_{1\infty} = f_1, f_{2\infty} = \infty.$

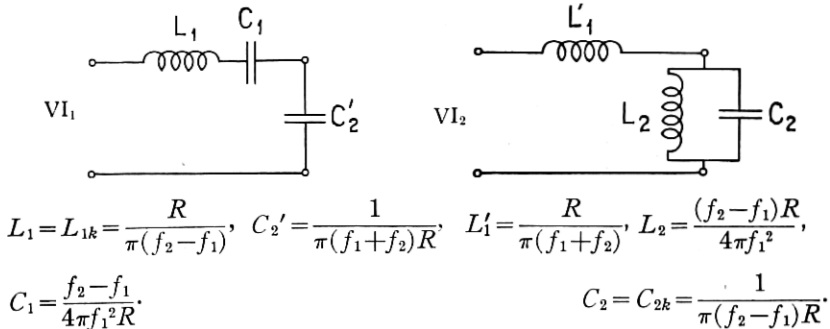

Four Element Structures

VII. "Constant k ," $f_{1\infty} = 0, f_{2\infty} = \infty, k = R.$

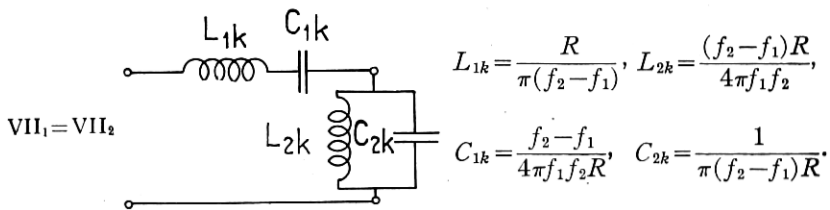

VIII. $f_{2\infty} = f_2.$

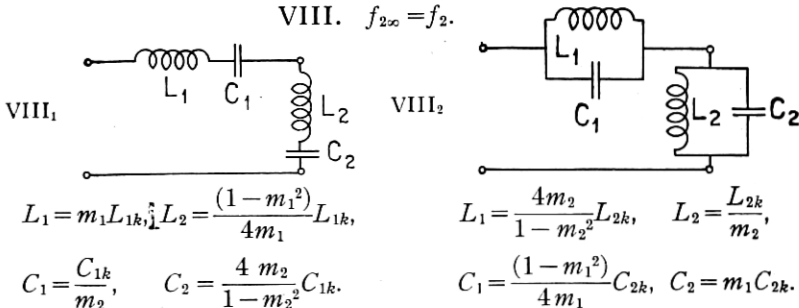

$$m_1 = \frac{f_1}{f_2} m_2, \quad m_2 = \sqrt{\frac{1 - \frac{f_{1\infty}}{f_1^2}}{1 - \frac{f_{1\infty}^2}{f_2^2}}}$$

Four Element Structures—(Continued)

IX. $f_{1\infty} = f_1$.

Same Structural Forms and L. C. Formulae as in VIII₁ and VIII₂.

$$m_1 = \sqrt{\frac{1 - \frac{f_2^2}{f_{2\infty}^2}}{1 - \frac{f_1^2}{f_{2\infty}^2}}}, \quad m_2 = \frac{f_1}{f_2} m_1.$$

Five Element Structures

X. $f_{1\infty} = 0$.

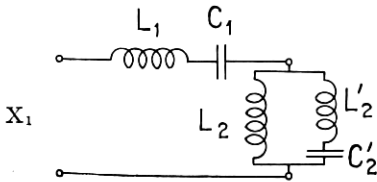

$$\begin{aligned} L_1 &= m_1 L_{1k}, & L_2 &= a L_{1k}, \\ C_1 &= C_{1k}, & L'_2 &= \frac{(1 - m_1^2)}{4h} L_{1k}, \\ & & C'_2 &= \frac{h}{a} C_{1k}. \end{aligned}$$

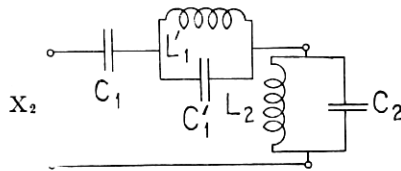

$$\begin{aligned} C_1 &= a C_{2k}, & L_2 &= L_{2k}, \\ L'_1 &= \frac{h}{a} L_{2k}, & C_2 &= m_1 C_{2k}, \\ C'_1 &= \frac{(1 - m_1^2)}{4h} C_{2k}. \end{aligned}$$

$$h = \sqrt{\left(1 - \frac{f_1^2}{f_{2\infty}^2}\right) \left(1 - \frac{f_2^2}{f_{2\infty}^2}\right)}, \quad m_1 = \frac{f_1 f_2}{f_{2\infty}^2} + h, \quad a = \frac{(1 - m_1^2) f_{2\infty}^2}{4 f_1 f_2}.$$

XI. $f_{2\infty} = \infty$.

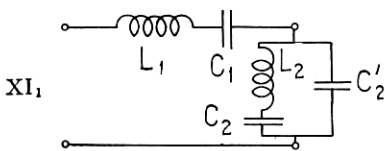

$$\begin{aligned} L_1 &= L_{1k}, & L_2 &= \frac{d}{g} L_{1k}, \\ C_1 &= \frac{C_{1k}}{m_2}, & C_2 &= \frac{4g}{1 - m_2^2} C_{1k}, \\ & & C'_2 &= \frac{C_{1k}}{d}. \end{aligned}$$

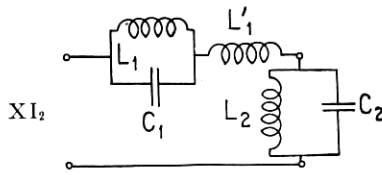

$$\begin{aligned} L_1 &= \frac{4g}{1 - m_2^2} L_{2k}, & L_2 &= \frac{L_{2k}}{m_2}, \\ C_1 &= \frac{d}{g} C_{2k}, & C_2 &= C_{2k}, \\ L'_1 &= \frac{L_{2k}}{d}. \end{aligned}$$

$$g = \sqrt{\left(1 - \frac{f_{1\infty}^2}{f_1^2}\right) \left(1 - \frac{f_{2\infty}^2}{f_2^2}\right)}, \quad m_2 = g + \frac{f_{1\infty}^2}{f_1 f_2}, \quad d = \frac{(1 - m_2^2) f_1 f_2}{4 f_{1\infty}^2}.$$

XII.—GENERAL LOW-AND-BAND PASS WAVE-FILTERS OF LADDER TYPE

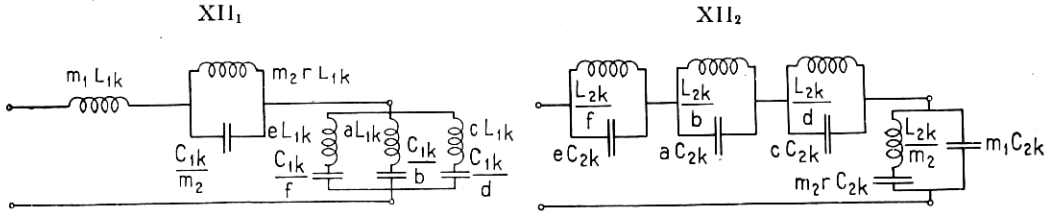

$$L_{1k} = \frac{R}{\pi(f_0 - f_1 + f_2)}, \quad L_{2k} = \frac{(f_0 - f_1 + f_2)^2 R}{4\pi[(f_0 f_1 - f_0 f_2 + f_1 f_2)(f_0 - f_1 + f_2) - f_0 f_1 f_2]}$$

$$C_{1k} = \frac{(f_0 - f_1 + f_2)^2}{4\pi[(f_0 f_1 - f_0 f_2 + f_1 f_2)(f_0 - f_1 + f_2) - f_0 f_1 f_2]R}, \quad C_{2k} = \frac{1}{\pi(f_0 - f_1 + f_2)R}$$

$$r = (f_0 - f_1 + f_2) \left(\frac{1}{f_0} - \frac{1}{f_1} + \frac{1}{f_2} \right) - 1,$$

$$g = \sqrt{\left(1 - \frac{f_0^2}{f_{1\infty}^2}\right) \left(1 - \frac{f_{1\infty}^2}{f_1^2}\right) \left(1 - \frac{f_1^2}{f_2^2}\right)}, \quad h = \sqrt{\left(1 - \frac{f_0^2}{f_{2\infty}^2}\right) \left(1 - \frac{f_{2\infty}^2}{f_2^2}\right) \left(1 - \frac{f_2^2}{f_{1\infty}^2}\right)},$$

$$m_1 = \frac{\frac{f_1 f_2}{f_{2\infty}^2} g + h}{1 - \frac{f_{1\infty}^2}{f_2^2}}, \quad m_2 = \frac{\left(\frac{f_0 - f_1 + f_2}{f_{2\infty}} - \frac{f_0 f_1 f_2}{f_{2\infty}^3}\right) g + \left(\frac{(f_0 - f_1 + f_2) f_{1\infty}^2}{f_1 f_2 f_{2\infty}} - \frac{f_0}{f_{2\infty}}\right) h}{\left[\left(1 - \frac{f_0}{f_1} + \frac{f_0}{f_2}\right) \left(\frac{f_0 - f_1 + f_2}{f_{2\infty}}\right) - \frac{f_0}{f_{2\infty}}\right] \left[1 - \frac{f_{1\infty}^2}{f_2^2}\right]}$$

$$a = \frac{f_0 f_1 f_2 r}{(f_0 - f_1 + f_2) f_{1\infty}^2} b,$$

$$b = \frac{(f_0 - f_1 + f_2)^2 [(1 - m_1^2) f_{1\infty}^4 f_{2\infty}^2 - f_0^2 f_1^2 f_2^2]}{4g r f_0 f_1^2 f_2^2 [(f_0 - f_1 + f_2) f_{1\infty}^2 - f_0 f_1 f_2]} \left(1 - \frac{f_{1\infty}^2}{f_2^2}\right),$$

$$c = \frac{f_0 f_1 f_2 r}{(f_0 - f_1 + f_2) f_{2\infty}^2} d,$$

$$d = \frac{(f_0 - f_1 + f_2)^2 [(1 - m_1^2) f_{1\infty}^2 f_{2\infty}^4 - f_0^2 f_1^2 f_2^2]}{4h r f_0 f_1 f_2 f_{1\infty}^2 [(f_0 - f_1 + f_2) f_{2\infty}^2 - f_0 f_1 f_2]} \left(1 - \frac{f_{1\infty}^2}{f_2^2}\right),$$

$$e = \frac{(1 - m_1^2) f_{1\infty}^2 f_{2\infty}^2 r}{(f_0 - f_1 + f_2) f_0 f_1 f_2},$$

$$f'_{1\infty} = \frac{f_0 f_1 f_2}{\sqrt{1 - m_1^2 f_{1\infty} f_{2\infty}}}$$

$$f = \frac{(f_0 - f_1 + f_2)^2}{4r f_{1\infty}^2 f_{2\infty}^2}$$

$$\frac{[(1 - m_1^2) f_{1\infty}^4 f_{2\infty}^2 - f_0^2 f_1^2 f_2^2] [(1 - m_1^2) f_{1\infty}^2 f_{2\infty}^4 - f_0^2 f_1^2 f_2^2]}{[(1 - m_1^2) (m_1 - h) f_{1\infty}^2 f_{2\infty}^4 - m_1 f_0^2 f_1^2 f_2^2] [(1 - m_1^2) f_{1\infty}^2 f_{2\infty}^2 - (f_0 - f_1 + f_2) f_0 f_1 f_2]}$$

APPENDIX III

EQUIVALENT NETWORKS AND TRANSFORMATION FORMULAE

Transformation A

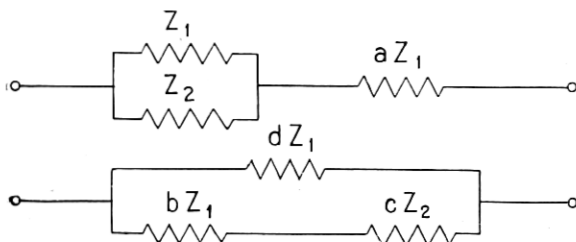

Equivalent when

$$b = a(1+a), \quad c = (1+a)^2, \quad d = 1+a.$$

Transformation B

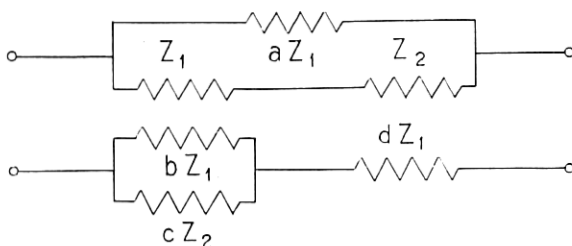

Equivalent when

$$b = \frac{a^2}{1+a}, \quad c = \left(\frac{a}{1+a}\right)^2, \quad d = \frac{a}{1+a}.$$

Transformation C

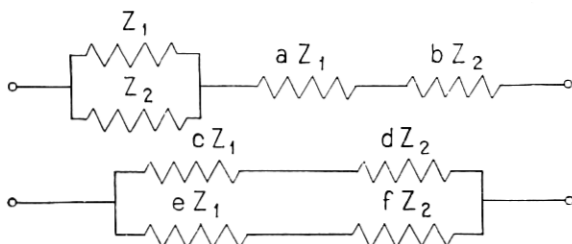

Equivalent when

$$c = \frac{N(M+N)}{M+N-2b}, \quad d = \frac{2bN}{M+N-2b},$$

$$e = \frac{N(M-N)}{N-M+2b}, \quad f = \frac{2bN}{N-M+2b},$$

$$M = 1+a+b,$$

$$N = \sqrt{(1+a+b)^2 - 4ab}.$$

Transformation D

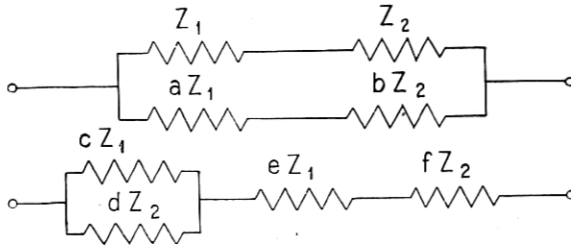

Equivalent when

$$c = \frac{(a-b)^2}{(1+a)(1+b)^2}, \quad d = \frac{(a-b)^2}{(1+a)^2(1+b)},$$

$$e = \frac{a}{1+a}, \quad f = \frac{b}{1+b}.$$

Transformation E

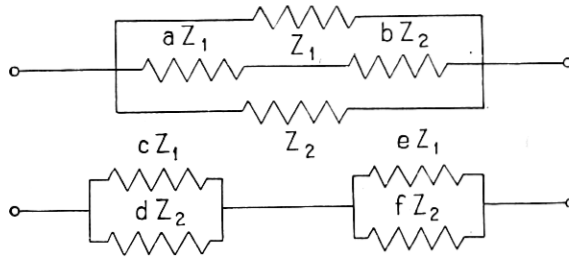

Equivalent when

$$c = \frac{(2b - M + N)(M + N)}{4bN}, \quad d = \frac{2b - M + N}{2N},$$

$$e = \frac{(M + N - 2b)(M - N)}{4bN}, \quad f = \frac{M + N - 2b}{2N},$$

$$M = 1 + a + b, \quad N = \sqrt{(1 + a + b)^2 - 4ab}.$$

Transformation F

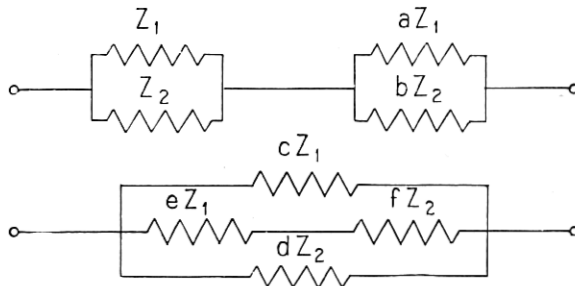

Equivalent when

$$c = 1 + a, \quad d = 1 + b,$$

$$e = \frac{a(1+a)(1+b)^2}{(a-b)^2}, \quad f = \frac{b(1+a)^2(1+b)}{(a-b)^2}.$$